

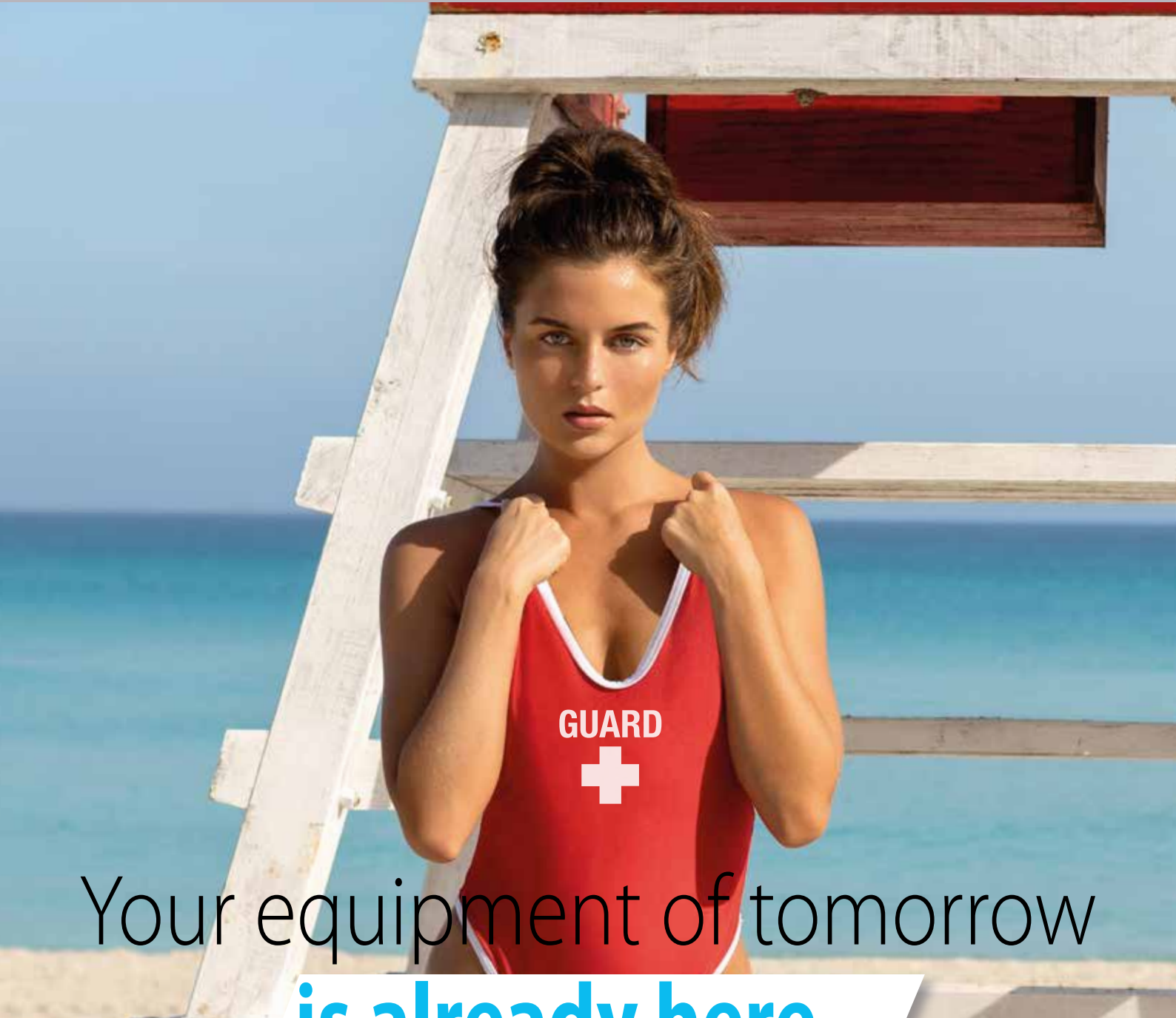

HEXAGONE
MANUFACTURE

100% PRO

2019-2020



Your equipment of tomorrow
is already here...



www.myhexagone.com

MADE IN FRANCE



Over 32 years of existence, almost 10 years have passed since Hexagone took a new turn, that of technology and extension of its catalogue in order to offer appropriate, reliable and intelligent equipment for public and collective pools.

Hexagone set the mission: to improve the working conditions of its clients through innovative products, that respect human and the environment, so that **technology is only useful for helping people!**

The equipment of tomorrow is already at Hexagone, with 12 new products for this new mission:

- 1/ To fight against the biofilm at the bottom of the basins and to reduce the chloramines and THM
- 2/ To clean regularly the buffer tank to simplify the emptying
- 3/ To help to suck under a mobile floor with a robot
- 4/ To navigate in a bio pool filled with algae
- 5/ To fight against sediments on gratings and in gutters
- 6/ To improve the life of lifeguards with a 360 ° platform, design and comfortable
- 7/ To provide super-resistant gutter gratings, free of heavy metals and anti-slip
- 8/ To create chlorine in the technical room of the swimming pool rather than transport it on the road
- 9/ To stop the users so that they all take a soapy shower before entering the water
- 10/ To take care of a fast and redundant information diffusion for the pool team in case of problems
- 11/ Challenging energy costs by adding a cover over swimming lines
- 12/ To take the robots out of the water and go clean synthetic lawns

Faithful to our demarche of free demonstrations, Hexagone goes to travel in your centres to meet you and present you the pool of tomorrow, more than ever intelligent, communicative and effective.

Thanks to you, Hexagone is present in more than **70%** of French public swimming pools. This honours us and obliges us.

We hope that you will find solutions to your problems in our new catalogue. All of our 75 employees are at your disposal to advise, demonstrate and keep track of your products.

At your service,
Your very devoted

President of Hexagone Manufacture, Mabis Group

Our references



2012: Summer Olympics
in London, United Kingdom



2016: Summer Olympics
in Rio, Brazil



2015: FINA World Championships
in Kazan, Russia



2017: FINA World Championships
in Budapest, Hungary



2018: FINA World Championships
in Hangzhou, China



2019: Pan American Games
in Lima, Peru

1 000
REFERENCES

POOL EXPERT SPECIALIST



Mask

Chlorine / pH
regulation



Cover
roller reels

WC



Sono

TECHNICAL AREA



Pump

Monobrush



SHOWER



Shampoo
distributor



Shower alarm
device



Unijet
elevator

Hairdryer



Baby Hexa chair



Scrubber

Changing room
plastic bench

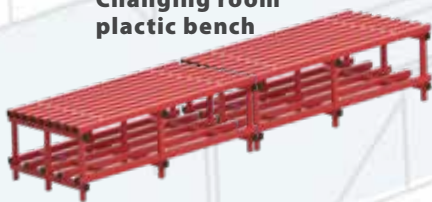

We have the
solution



Swimsuit
wringer

Non-contractual photos.



Non-contractual photos.

Residential	PAGE 8
Semi-pro	PAGE 10
Commercial pools	PAGE 12
Aquatic Center	PAGE 14
Anti-biofilm solution	PAGE 20
Natural pool	PAGE 26

Quick Vac'	PAGE 32
Quick Vac' Cyclone	PAGE 34
Quick Vac' Spa	PAGE 35
Rotating brush	PAGE 36
Cleaning trolley	PAGE 37
Scrubbers	PAGE 38
Steam rotobrushes	PAGE 39

Intensive use	PAGE 42
Regular use	PAGE 44
Chairs	PAGE 46
Hydraulic	PAGE 48
Hoist	PAGE 50
Motorized	PAGE 51

Lifeguard chairs	PAGE 56
Lifeguard platforms	PAGE 58
Security	PAGE 60
Swimming lanes	PAGE 64
Starting blocks	PAGE 67
Games	PAGE 67

Hexa Sono	PAGE 70
Design Bike	PAGE 72
Design multi-activity	PAGE 74
Sport Bike	PAGE 76
Sport run & jump	PAGE 78
Aquatic Walks X-Treme Power	PAGE 79

Shower, changing rooms, wellness	PAGE 82
Storage - gutter grates - analysis	PAGE 90
Treatment - covering - shelter	PAGE 94



Residential

Semi-pro

Commercial pools



PAGE 8



PAGE 10



PAGE 12



Non-contractual photos.

Automatic

robotic cleaners



To choose well...

- Pool size
- Budget
- Pool type
- Normal or intensive use

Aquatic Center



PAGE 14



Anti-biofilm solution



PAGE 20



Natural Pool



PAGE 26



Non-contractual photos.



Top of the range

5 years warranty*

*or 800 hours



CROCODILE ROCK



WARRANTY
5 YEARS

OR 800 HOURS ON
MOTORS AND PUMP

Floating arm
with LED



100 micron
filter



Robot for private
swimming pools
use exclusively

Non-contractual photos.

NEW!

The assurance of effective and precise cleaning via a gyroscope

Fruit of the experience on the market of public swimming pools robots

Short or intensive program cycle, bottom or bottom / walls

Double ultra-filtering large capacity bags

Can be delivered with trolley and remote control



Sophisticated and elegant design

Our designer: Jan Bujak

The new **Crocodile Rock** robot comes from Jan Bujak's design studio, which regularly works with Elon Musk on the hyperloop project or with the Volkswagen group.

His signature now crowns our robot **Crocodile Rock**, with a powerful design, embodying sportiness, dynamism and emotion, for a high-end model.



Technical data

SERIE 1 B

SERIE 3 B

SERIE 5 NEON B

SERIE 8 XD B



ON BATTERY

Mode	Floor	Floor and wall	Floor and wall	Floor and wall
Pool length	Up to 15 m	Up to 15 m	Up to 18 m	Up to 18 m
Cleaner width	40 cm	40 cm	40 cm	40 cm
Cleaning speed	10 to 18 m/min	10 to 18 m/min	10 to 18 m/min	10 to 18 m/min
Suction power	23 m³/h	23 m³/h	23 m³/h	23 m³/h
Weight out of water/ in water	7,5 kg/ 1,5 kg	9 kg/ 2 kg	9 kg/ 2 kg	9 kg/ 2 kg (without battery)
Cable length	16 m	18 m	20 m	With battery
Trolley	Without	With	With	With
Remote control	Without	Without	With	With
Filtration capacity	3,1 kg	3,1 kg	3,1 kg	3,1 kg
Power supply	110 v-240 v / 24 vdc	110 v-240 v / 24 vdc	110 v-240 v / 24 vdc	12 Volts
Autonomy/ Charge time	—	—	—	3 h (autonomy) / 6 h (charge)
Brush type	PVC, option PVA	PVC, option PVA	PVC, option PVA	PVC, option PVA
References	xygps01	xygps03	xygps05	xygps08

The warranty is 2 years for parts and work in workshop. (Excludes consumables). Non-contractual photos.



The ally for outdoor hotel pools

SPOT

AQUA POSITIONING TECHNOLOGY



NEW!

Carbon plast shell



SPOT
AQUA POSITIONING TECHNOLOGY

Floating battery

WARRANTY
2
YEARS



Non-contractual photos.

With waterproof remote control





Model with battery or without it

Smart cleaning with integrated gyro

High filtration fineness, 100 microns

Ability to clean pools with islets

Ultra-light for the user

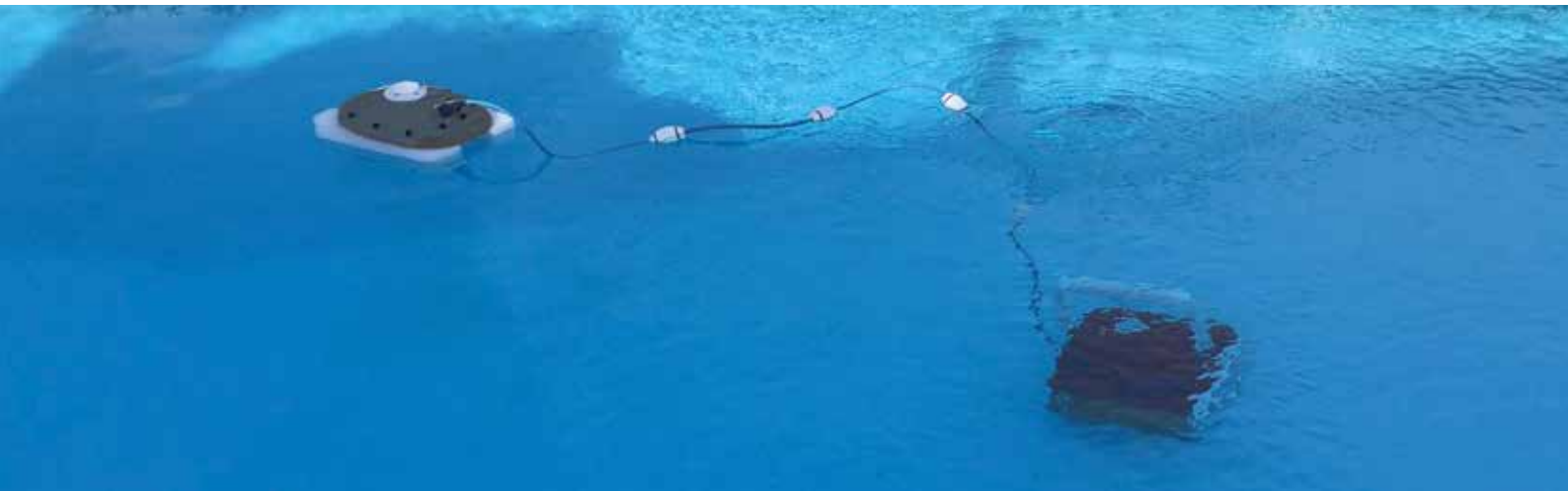

Technical data



Mode
Pool length
Cleaner width
Cleaning speed
Suction power
Weight out of water/ in water
Cable length
Trolley
Remote control
Filtration capacity
Power supply
Autonomy/ Charge time
Brush type
References

SPOT PRO 100 A



Floor and wall
Up to 25 m
40 cm
10 to 15 m/min
27 m³/h
9 kg/ 2 kg
30 m
With
With
3,1 kg
110 v-240 v / 24 vdc
—
PVC, option PVA
xygppsp100

SPOT PRO 150 XD A



Floor and wall
Up to 20 m
40 cm
10 to 15 m/min
27 m³/h
9 kg/ 2 kg
With battery
With
With
3,1 kg
12 Volts
3 h (autonomy) / 6 h (charge)
PVC, option PVA
xygppsp150

SPOT DUO 200 A



Floor
Up to 50 m
78 cm
10 to 15 m/min
50 m³/h
18 kg/ 4 kg
40 m
With
With
6,2 kg
110 v-240 v / 24 vdc
—
PVC, option PVA
xygppsp200

The warranty is 2 years for parts and work in workshop. (Excludes consumables). Non-contractual photos.



The robot with **hard bristles**



SCAN TO WATCH THE VIDEO

NINJA PUMP TECHNOLOGY



peps
machine



Sucks in 15 cm up to 5 meters deep



Ideal for paddling pools

360°

Anti-twist of the cable, rotation sensor

4 filtration fineness from 75 to 1000 microns



Comes complete with stainless steel trolley and 30m cable

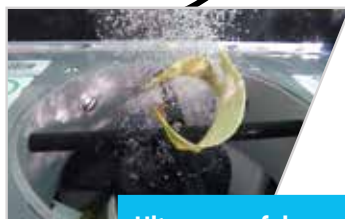
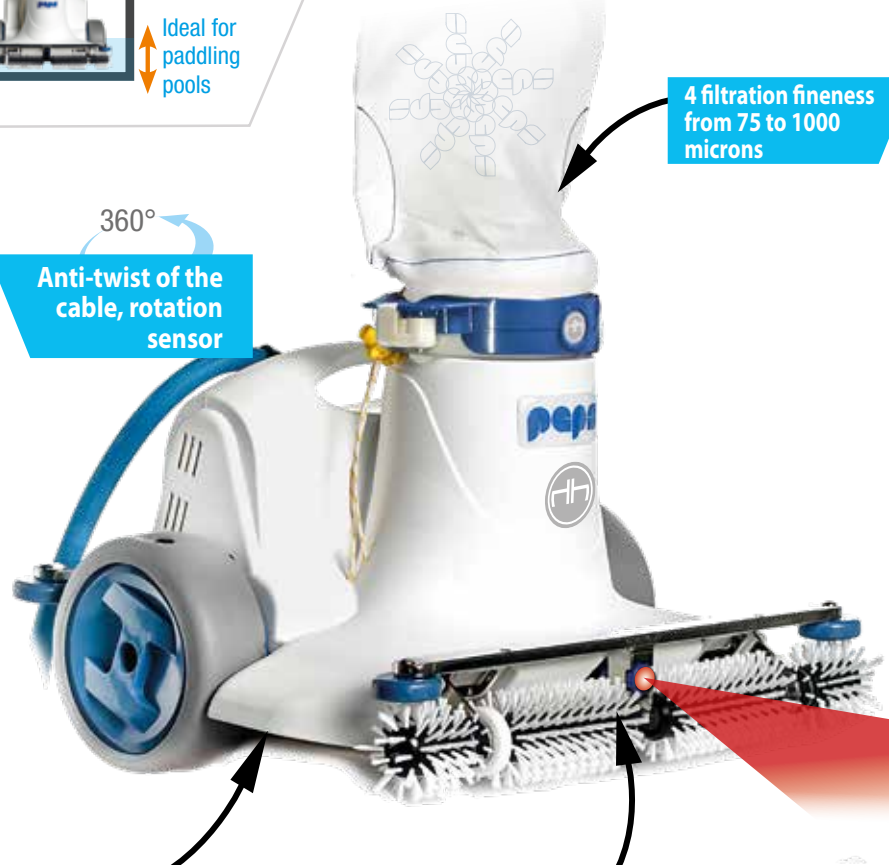

Ultra powerful Ninja Pump

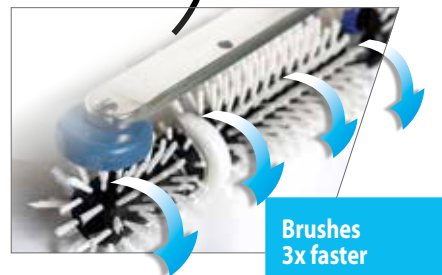

Brushes 3x faster

Non-contractual photos.

Brushing function multiplied via rotary brush

Equipment is easy to use via its touch screen

Compact, lightweight and handy robot

Versatility of work for outstanding efficiency

For pools with slope less than 25 degrees



Floating, waterproof and shockproof radio remote control

The robot goes alone to the water via its radio remote control

- Long range
- 8 functions



Technical data

PEPS 200 A

PEPS 300 A



Pool length	Up to 25 m	25 to 50 m
Cleaner width	40 cm	60 cm
Cleaning speed	10 m/mn	12 m/mn
Suction power	37 m ³ /h	37 m ³ /h
Weight out of water/ in water	14 kg/ 2 kg	17 kg/ 2 kg
Cable length	30 m (supplied)	40 m (supplied), 30 m in option
Trolley	In stainless steel (supplied)	In stainless steel (supplied)
Filtration capacity	4 kg of sand	6 kg of sand
IR (detection walls)	1	1
Power supply	110 v-240 v / 12 vdc	110 v-240 v / 12 vdc
References	xypeps200	xypeps300 (Available 09/2019)

Smart Navigation



Gyroscope



FILTERS

75 microns	
Fine filtration xzpepsf01n02	
105 microns	
Classic filtration (delivered as standard) xzpepsf01n01	
250 microns	
Filtration for exteriors xzpepsf01n03	
1000 microns	
Filtration for reopen the pool xzpepsf01n04	

The warranty is 2 years for parts and work and on-site visits. (Excludes consumables). Non-contractual photos.



The best-selling robot in France*



SCAN TO WATCH
THE VIDEO

* In public pools

Chrono mp3



Umbrella filter
without touching
impurities

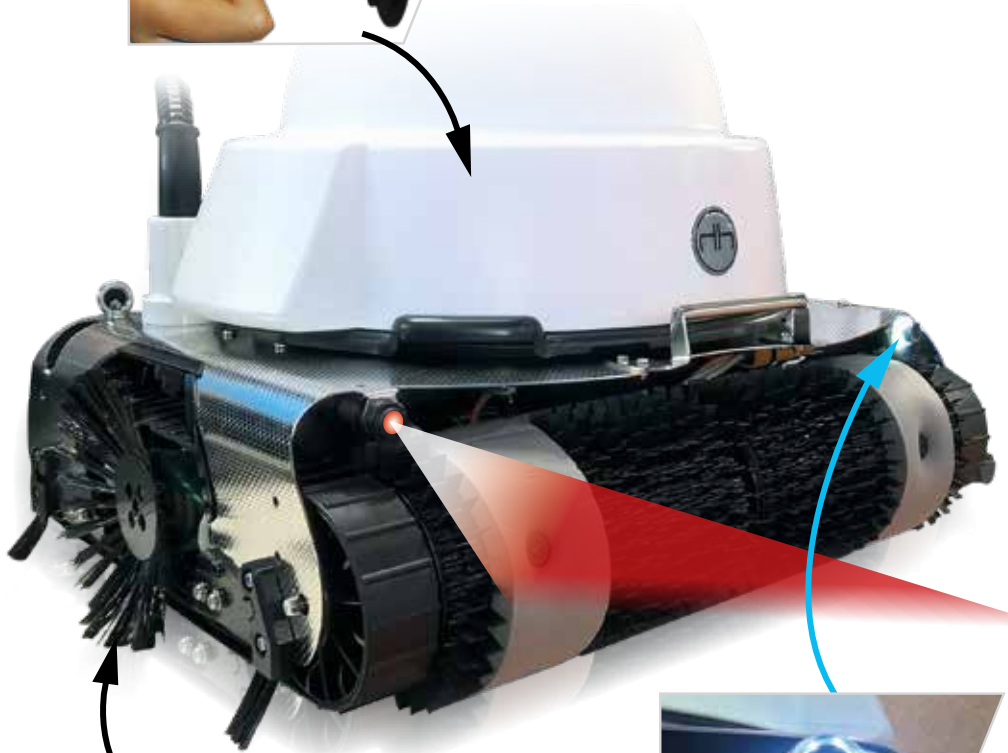
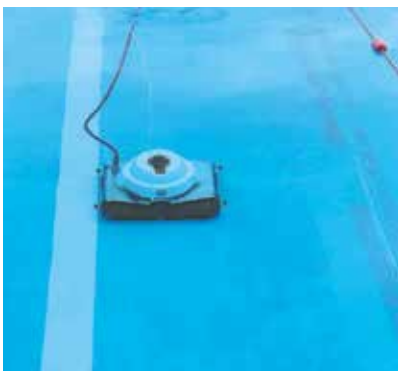
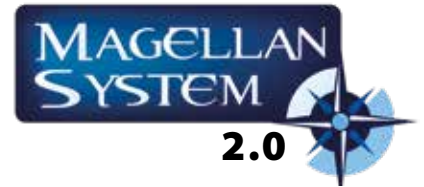

Lateral brush for
bottom edge



MP4 waterproof
camera for mobile
bottom optional

Non-contractual photos.

Professional quality, stainless steel chassis

Optimum coverage and speed of cleaning

Choice of 6 filtration fineness

Floor or floor and walls program

On-site maintenance with Plug & Play technology



Customize
your robot
page 16.

Technical data

CHRONO MP3 M **A**

CHRONO MP3 L **A**

CHRONO MP3 XL **A**

Chrono
mp3



Pool length	Up to 25 m	25/33 m	50/60 m
Cleaner width	50 cm	60 cm	75 cm
Cleaning speed	10 to 18 m/min	10 to 18 m/min	10 to 18 m/min
Suction power	50 m ³ /h	50 m ³ /h	50 m ³ /h
Weight out of water/ in water	22 kg/ 3 kg	23 kg/ 3 kg	24 kg/ 3 kg
Filtration capacity	3,1 kg	3,1 kg	3,1 kg
IR (detection walls)	2 or 4	2 or 4	2 or 4
Power supply	110 v-240 v / 24 vdc	110 v-240 v / 24 vdc	110 v-240 v / 24 vdc
References	xcmp3m-std	xcmp3l-std	xcmp3xl-std

The warranty is 2 years for parts and work and on-site visits. (Excludes consumables). Non-contractual photos.



Configurator

AUTO CLEANING MODES

DUO MODE possible



Hexpresso

Ultra fast
10' for 25m
30' for 50m.

Systematic

Fast
- 45' for 25m
- 1h30' for 50m.
xzcmp3e02n03

Magellan cross

Classic
- 1h15' for 25m
- 3h for 50m.
xzcmp3e02n01

V-shape

Long
- 2h30 for 25m
- 5h for 50m.
xzcmp3e02n04

Floor & walls

Very long
- 3h30' for 25m
- 6h for 50m.
xzcmp3e02n02

CABLES



25 m

Free-floating reinforced PVC coating
xzcmp3c01n02 (for MP3)
xzcmp3c02n01 (for MP4)



32 m

Free-floating reinforced PVC coating
xzcmp3c01n04 (for MP3)
xzcmp3c02n02 (for MP4)



40 m

Free-floating reinforced PVC coating
xzcmp3c01n05 (for MP3)
xzcmp3c02n03 (for MP4)



50 m

Free-floating reinforced PVC coating
xzcmp3c01n06 (for MP3)
xzcmp3c02n04 (for MP4)

TROLLEYS



Dispenser

With dispenser and 2 forks
xzcmp3k01n01



25-32 m Reel

Shared trolley with cable reel
xzcmp3k01n02



40-50 m Reel

Shared trolley with cable reel
xzcmp3k01n03



Winch trolley

Equipped with gallows with winch
xzcmp3k01n04

CAMERA



Special mobile bottom



Camera option

Waterproof camera IP68 with 8 leds

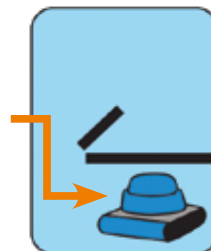

The warranty is 2 years for parts and work and on-site visits. (Excludes consumables). Non-contractual photos.

FILTERS



20 microns

Very fine.
Algae, fungus, diatom
xzcmp3f01n03



75 microns

Fine.
Sands, algae
xzcmp3f01n07



105 microns

Classic.
Sands, hair, plasters
xzcmp3f01n01



250 microns

For exteriors.
Leaves, gravel
xzcmp3f01n02

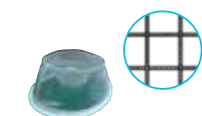

1000 microns

For reopen the pool.
Leaves, piercings
xzcmp3f01n04



2000 microns

For reopen the pool.
Large debris, stones.
xzcmp3f01n08



Leaves plate

1 cm.

fb0002n000



TOP 1

Extra filtration, TOP1 bag.
Adaptable to all filter finesses.
pb0080n000 + pb0081n000 + qp0025n001

(without filter, contact us)



BRUSHES

PVC

For M
xzcmp3d02n03
xzcmp3d02n06 (for walls)
For L
xzcmp3d01n09
xzcmp3d01n12 (for walls)
For XL
xzcmp3d02n15
xzcmp3d02n18 (for walls)

Sticky floor



Mixed

For M
xzcmp3d01n01
xzcmp3d02n04 (for walls)
For L
xzcmp3d01n07
xzcmp3d02n10 (for walls)
For XL
xzcmp3d01n13
xzcmp3d02n16 (for walls)

Normal floor



PVA

For M
xzcmp3d01n02
xzcmp3d02n05 (for walls)
For walls L
xzcmp3d02n08
xzcmp3d01n11 (for walls)
For XL
xzcmp3d02n14
xzcmp3d02n17 (for walls)

Slippery floor



ACCESSORIES



Remote power supply

xzcmp3e03n03



Re-lift kit M/L/XL

xzcmp3a01n04/5/6



Outdoor cover

ka0203n000



Great depth Kit

xzcmp3h01n03



Saltwater Kit

xzcmp3e01n02



Liner M/L/XL Kit

xzcmp3e00n04/5/6

The warranty is 2 years for parts and work and on-site visits. (Excludes consumables). Non-contractual photos.

Cleaning modes



Ultra fast

Partial covering



Hexpresso mode

75% of the impurities collected
- 10 min for 25 m - 30 min for 50 m
Contact us



Fast

Unique covering

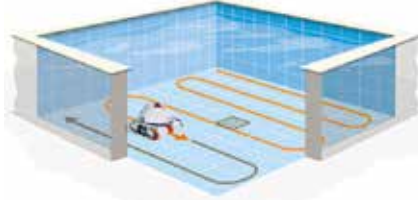

Systematic mode

Tape by tape, parallel lines
- 45 min for 25 m - 1h30 for 50 m
zxcmp3e02n03

Classic

Double covering



Magellan cross mode

Passage by perpendicular lines
- 1h15 for 25 m - 3h for 50 m
zxcmp3e02n01

Long

Triple or quadrupled covering

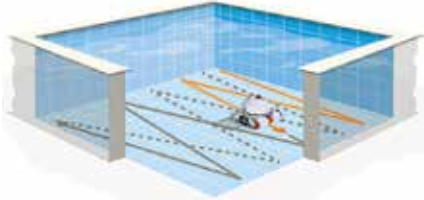

V-shape mode

Moving by V-lines, numerous passages
- 2h30 for 25 m - 5h for 50 m
zxcmp3e02n04

Very long

Total covering



Floor and walls mode

Moving in perpendicular lines with adjustable wall climbing
- 3h30 for 25 m - 6h for 50 m
zxcmp3e02n02



DUO

Auto 1

Auto 2



COMBI mode

Possibility to combine 2 cleaning modes automatically to link 1 auto mode and 2 auto mode of your choice.

Robot sensors

Detectors of walls, slopes, sides, virtual walls:

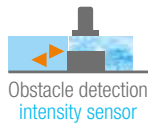
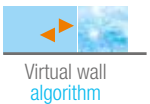
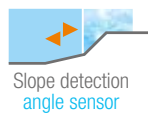
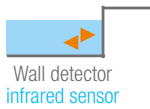

Trajectory management control:

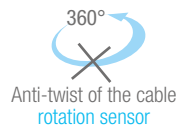
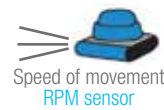

Pool cleaner safety management:

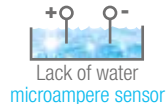

Pool types

Whatever the shape:



Whatever the pool floor:

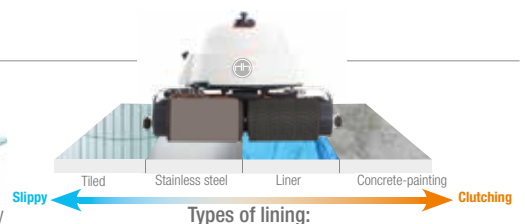

Non-contractual photos.

A colour touch screen interface

Cleaning mode depending on available time

Human / machine touch interface



Touch dashboard



REMOTE CONTROL MENU
Manipulation with the remote control

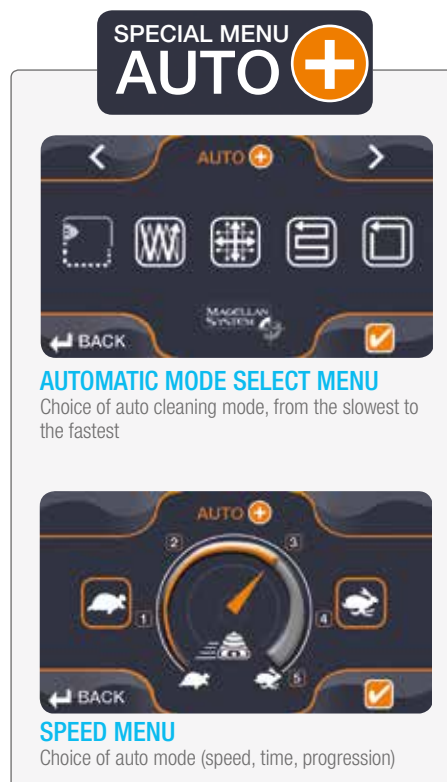

AUTOMATIC MODE SELECT MENU
Choice of auto cleaning mode, from the slowest to the fastest



IMMEDIATE OR DELAYED STARTUP MENU
Visualization of the progression in automatic mode



INFO-SETTINGS MENU
Robot elements control panel, list of 10 faults, data panel, settings menu



SPEED MENU
Choice of auto mode (speed, time, progression)

Non-contractual photos.



Can a robotic va
reduce chem
and make wat

ANTIBACTERIAL

1

Filter the **visible**

from 20 microns

Bandages - hair - leaves...

INSIDE THE ROBOT...

PREFILTER

all impurities visible at the bottom of the basin (leaves, sand, bandages) are trapped in the filter bag of the robot.

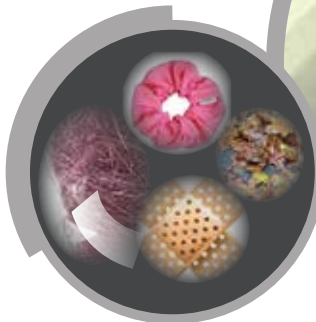

Non-contractual photos.

Filter of robot

1

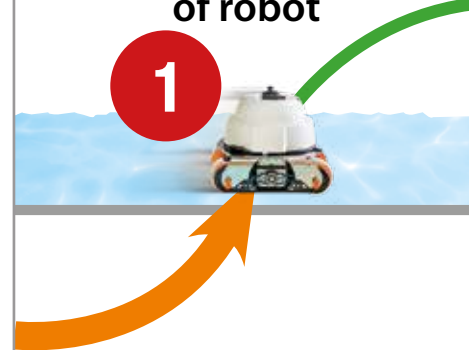

RESULT: REMOVAL

NOVELTY

BIOFILM SOLUTION

cuum cleaner
ical intake
er healthier?

ROBOT VIKING

2

Extract **the invisible**

up to 0.05 microns

Bacteria - microscopic impurities...

THROUGH AN EVACUATION PIPE...

DISCHARGE

water, loaded with particles and **invisible** bacteria, enters the gutters to go into the main filtration.

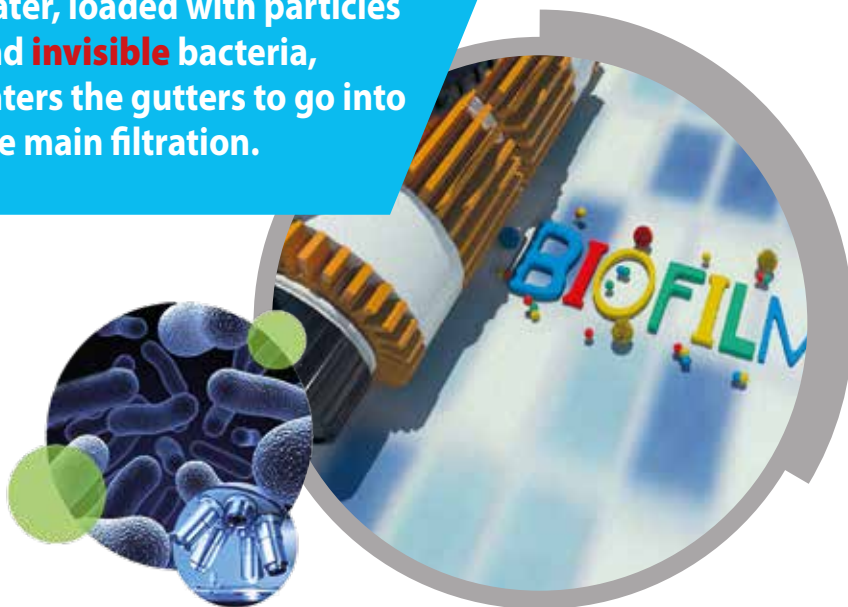
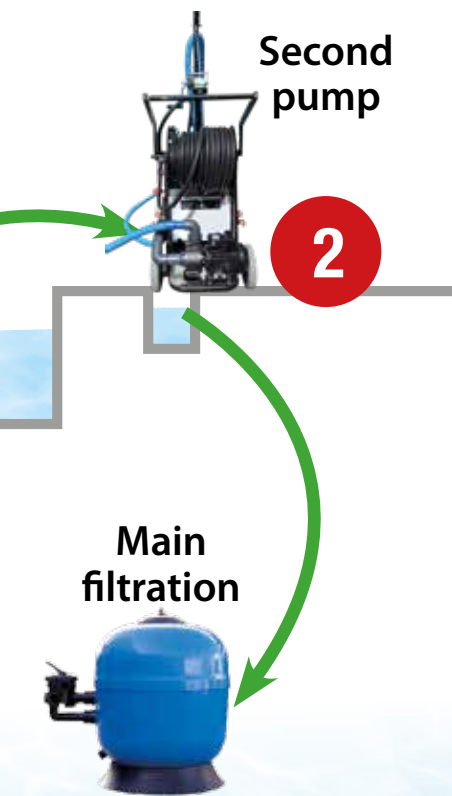

Non-contractual photos.

OF 99.8% BACTERIA



The armed arm of swimming pool filtration



SCAN TO WATCH THE VIDEO

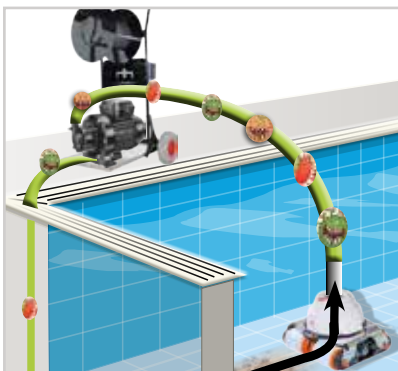
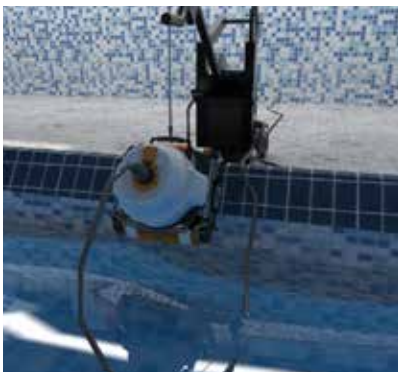

1st pump in the robot

2nd pump to discharge water into the main filtration



Water presence sensor



The warranty is 2 years for parts and work and on-site visits. (Excludes consumables). Non-contractual photos.



*According to the study made by Teknologisk Institute, Denmark

Sucks and extracts the biofilm at the bottom of 5 cm

Reduces chemical intake

Helps to remove bacteria from the bottom of basin

Significant reduction in chloramine level

The robot becomes the arm of your filtration



UNIQUE
technology

in the
WORLD*

* International patent pending



Technical data

VIKING M A

VIKING XL A



Customize
your robot
page 16.

Pool length
Cleaner width
Cleaning speed
Suction power
Weight out of water/ in water
Inside filtration capacity
IR (detection walls)
Power supply
References

Up to 25 m
50 cm
10 to 15 m/min
50 m³/h
22 kg/ 3 kg
3,1 kg
2 or 4
110 v-240 v / 24 vdc
xcmp3m-std510vkg

50/60 m
75 cm
10 to 15 m/min
50 m³/h
24 kg/ 3 kg
3,1 kg
2 or 4
110 v-240 v / 24 vdc
xcmp3xl-stdvkg



The warranty is 2 years for parts and work and on-site visits. (Excludes consumables). Non-contractual photos.



A robot dedicated to **a balance tank**



SCAN TO WATCH
THE VIDEO



Permanently stays in a balance tank

Innovative automatic cleaning solution

Much simpler and safer for agents

Real daily cleaning before emptying

Fights against chloramine and sediments

The warranty is 2 years for parts and work and on-site visits. (Excludes consumables). Non-contractual photos.

Automatic balance tank cleaner



External pump

Technical data

Pool length
Cleaner width
Cleaning speed
Suction power
Weight out of water/ in water
Cable length
Trolley
Filtration capacity
IR (detection walls)
Power supply
References

DARK CLEANER B

Balance tank
40 cm
8 m/mn
30 m3/h
14 kg/ 2 kg
16 m (supplied)
In stainless steel (supplied)
External
1
110 v-240 v / 12 vdc
xypeps100vkg



The warranty is 2 years for parts and work and on-site visits. (Excludes consumables). Non-contractual photos.



Technology



1

LEVEL 1 FILTRATION

PREFILTER

Large impurities at the bottom of the pond (leaves, sand, stones) are trapped thanks to the pre-filter of the robot.



Non-contractual photos.

SOLUTION 3 IN 1

FUNNEL FILTRATION

2

LEVEL 2 FILTRATION

EXTRACTION

of the water coming from the robot which passes through the filter cartridge of the system (via an external pump).



3

LEVEL 3 FILTRATION

FINAL STAGE

the filtered water 2 passes into a new series of ultrafine bags before being discharged into the pool.



Non-contractual photos.

Cleaning for **natural pools**

3 in 1 funnel filtration system

Perfect for natural pools

Allows filtering of very large quantities of waste

Deep depth cleaning solution



Drum filter for bio pool F

Stainless steel 304L or 316L.
Dimensions: W.473 x D.693 x H.577 mm.
Weight 80 kg. Recommended pressure 5 bar.
Contact us

The warranty is 2 years for parts and work and on-site visits. (Excludes consumables). Non-contractual photos.

Technical data

BIO-MATIC M A

BIO-MATIC XL A

KIT BIO-MATIC System A

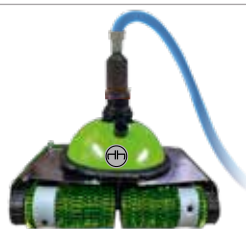

Pool surface 1000 m²
 Cleaner width 50 cm
 Cleaning speed 10 to 15 m/min
 Suction power 50 m³/h
 Weight out of water/ in water 22 kg/ 3 kg
 Inside filtration capacity 3,1 kg
 IR (detection walls) 2 or 4
 Power supply 110 v-240 v / 24 vdc
 References Contact us

1000 m²
 50 cm
 10 to 15 m/min
 50 m³/h
 22 kg/ 3 kg
 3,1 kg
 2 or 4
 110 v-240 v / 24 vdc
 Contact us

1500 m²
 75 cm
 10 to 15 m/min
 50 m³/h
 24 kg/ 3 kg
 3,1 kg
 2 or 4
 110 v-240 v / 24 vdc
 Contact us

Kit Robot pre-filter + Quick Vac' Cyclone + fork with 4 filter-bags (for existing Hexagone robot)
 With our 4 specific bags, you can choose the grid of 20, 75, 105, 250, 1000 or 2000 microns.
 Delivered with a 5 m hose for water discharge and a 25 m hose for suction.
 Other lengths of hose, consult us.
 Contact us



Manual brushes for natural pools

Technical data

Lineo XL large depth A

Lineo rotary brush XXL A

Quick Vac Bio Vacuum F



For rollers contact us



Brush size
 Power supply
 Telescopic rod
 Battery charger
 Autonomy
 Weight
 Brushes
 Dimensions (folded WxDxH)
 Références

ø 22 cm
 24V Li-Ion battery
 250 to 500 cm
 Serial
 >1h to 2h
 4 kg
 Rotating nylon brush (optional pad)
 —
 xlineobb22n000
 Delivered with a brush

Width 44 cm
 24V Li-Ion battery
 250 to 500 cm
 Serial
 >2h to 3h
 6 kg
 Rotating nylon roller
 —
 xlineobs44n000
 Delivered with a black roll

—
 110V-240V
 250 to 500 cm
 —
 —
 32,5 kg
 Triangular brush
 85 x 46 x 62 cm
 z260ftorultra

Fits with Lineo brushes

Non-contractual photos.

Hexagone, the largest range of po

RESIDENTIAL POOL VACUUM

Technical data

SERIE 1 B

SERIE 3 B

SERIE 5 B

SERIE 8 B



Use
Basin area
Width of the vacuum cleaner
Cleaning speed
Suction power
Cable length
Trolley
Filtration capacity
Infra red (detection walls)
Power supply
Camera
Weight out of water / in water
Minimum water depth
Page number

Normal
60 m²
40 cm
10 to 18 m/min
23 m ³ /h
16 m
No
No
110 v-240 v / 24 vdc
No
7,5 kg/ 1,5 kg
30 cm
8

Normal
60 m²
40 cm
10 to 18 m/min
23 m ³ /h
18 m
Yes (supplied)
3,1 kg
No
110 v-240 v / 24 vdc
No
9 kg/ 2 kg
30 cm
8

Normal
80 m²
40 cm
10 to 18 m/min
23 m ³ /h
20 m
Yes (supplied))
3,1 kg
No
110 v-240 v / 24 vdc
No
9 kg/ 2 kg
30 cm
8

Normal
80 m²
40 cm
10 to 18 m/min
23 m ³ /h
With battery
Yes (supplied)
3,1 kg
No
12 volts battery
No
9 kg/ 2 kg
30 cm
8

AQUATIC CENTER POOL VACUUM

Technical data

CHRONO MP3 M A

CHRONO MP3 L A

CHRONO MP3 XL A

Technical data



Use
Basin area
Width of the vacuum cleaner
Cleaning speed
Suction power
Cable length
Trolley
Filtration capacity
Infra red (detection walls)
Power supply
Camera
Weight out of water / in water
Minimum water depth
Page number

Intensive
300 m²
50 cm
10 to 18 m/min
50 m ³ /h
25, 32, 40 or 50 m
Stainless steel (4 types)
3,1 kg
2 or 4
110 v-240 v / 24 vdc
Yes (MP4)
22 kg/ 3 kg
40 cm
14

Intensive
495 m²
60 cm
10 to 18 m/min
50 m ³ /h
25, 32, 40 or 50 m
Stainless steel (4 types)
3,1 kg
2 or 4
110 v-240 v / 24 vdc
Yes (MP4)
23 kg/ 3 kg
40 cm
14

Intensive
1250 m²
75 cm
10 to 18 m/min
50 m ³ /h
25, 32, 40 or 50 m
Stainless steel (4 types)
3,1 kg
2 or 4
110 v-240 v / 24 vdc
Yes (MP4)
24 kg/ 3 kg
40 cm
14

Use
Basin area
Width of the vacuum cleaner
Cleaning speed
Suction power
Cable length
Trolley
Filtration capacity
Infra red (detection walls)
Power supply
Camera
Weight out of water / in water
Depth of water mini
Page number

The warranty is 2 years for parts and work and on-site visits. (in workshop for Crocodile rock and Squirrel). Excludes consumables. Non-contractual photos.

ols vacuum robots on the market

SEMI-PRO POOL VACUUM

SPOT PRO 100 A



Intensive
200 m²
40 cm
10 to 15 m/min
27 m ³ /h
30 m
Yes (supplied)
3,1 kg
No
110 v-240 v / 24 vdc
No
9 kg/ 2 kg
30 cm
10

SPOT PRO 150 XD A

ON BATTERY



Intensive
150 m²
40 cm
10 to 15 m/min
27 m ³ /h
With battery
Yes (supplied)
3,1 kg
No
12 volts battery
No
9 kg/ 2 kg
30 cm
10

SPOT DUO 200 A



Intensive
400 m²
78 cm
10 to 15 m/min
50 m ³ /h
40 m
Yes (supplied)
6,2 kg of sand
1
110 v-240 v / 24 vdc
No
18 kg/ 4 kg
30 cm
10

COMMERCIAL POOL VACUUM

PEPS 200 A



Intensive
250 m²
40 cm
10 m/min
37 m ³ /h
30 m (supplied)
In stainless steel (supplied)
4 kg of sand
1
110 v-240 v / 12 vdc
No
14 kg/ 2 kg
15 cm
12

PEPS 300 A



Intensive
400 m²
60 cm
12 m/min
37 m ³ /h
40 m (supplied), 30 m in option
In stainless steel (supplied)
6 kg of sand
1
110 v-240 v / 12 vdc
No
17 kg/ 2 kg
15 cm
12

BIOFILM SOLUTION POOL VACUUM

DARK CLEANER B



Ultra filtration
100 m²
40 cm
8 m/min
30 m ³ /h
16 m
In stainless steel (supplied)
External
1 (detection walls)
110 v-240 v / 12 vdc
No
14 kg/ 2 kg
50 cm
24

VIKING M A



Ultra filtration
350 m²
50 cm
10 to 15 m/min
50 m ³ /h
25, 32, 40 or 50 m
Stainless steel (winch trolley)
3,1 kg (inside)
2 or 4
110 v-240 v / 24 vdc
Yes (MP4)
22 kg/ 3 kg
50 cm
22

VIKING XL A



Ultra filtration
800 m²
75 cm
10 to 15 m/min
50 m ³ /h
25, 32, 40 or 50 m
Stainless steel (winch trolley)
3,1 kg (inside)
2 or 4
110 v-240 v / 24 vdc
Yes (MP4)
24 kg/ 3 kg
50 cm
22

NATURAL POOL VACUUM

BIO-MATIC M A

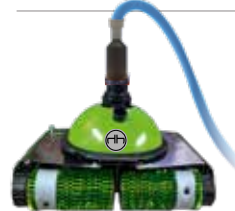

Biopool
1000 m²
50 cm
10 to 15 m/min
50 m ³ /h
25, 32, 40 or 50 m
Stainless steel (winch trolley)
3,1 kg (inside)
2 or 4
110 v-240 v / 24 vdc
Yes (MP4)
22 kg/ 3 kg
50 cm
28

BIO-MATIC XL A



Biopool
1500 m²
75 cm
10 to 15 m/min
50 m ³ /h
25, 32, 40 or 50 m
Stainless steel (winch trolley)
3,1 kg (inside)
2 or 4
110 v-240 v / 24 vdc
Yes (MP4)
24 kg/ 3 kg
50 cm
28

The warranty is 2 years for parts and work and on-site visits. (in workshop for Crocodile rock and Squirrel). Excludes consumables. Non-contractual photos.



Boost

your maintenance



SCAN TO WATCH THE VIDEO

Quickvac'



- 75 microns
Fine filtration
- 100 microns
Classic filtration
- 250 microns
Filtration for exteriors
- 1000 microns
Filtration for reopen the pool

Telescopic handle



Autonomous filter

Cable 14 m

N°1 in sales!

QUICK VAC'
PADDING POOL



Battery not supplied

Four 360° rotating wheels



Non-contractual photos.



Manual vacuum on 12V battery

Direct suction into own filter bag

Easy handling with 4 wheels 360°

Ideal for small pools, sucks from 15 cm of water*

Delivered with a transport trolley



Technical data

Quick Vac'

Option sector

*Quick Vac' Padding pool **A**

Quick Vac' classic **A**

Quick Vac' XL **B**



40 cm



40 cm



110 cm

Width	40 cm	40 cm	110 cm
Suction power	40m ³ /h	40m ³ /h	40m ³ /h
Trolleys/ Chassis	Painted aluminium/UNBS	Painted aluminium/UNBS	Painted aluminium/UNBS
Cable length	14 m	14 m	21 m
Weight out of water	5 kg	5 kg	7 kg
Pump	250 W	250 W	250 W
Filtration (microns)	75, 100, 250, 1000 μ	75, 100, 250, 1000 μ	75, 100, 250, 1000 μ
Filtration capacity	2kg	4 kg	6 kg
Autonomy	3h	3h	3h
Power supply	12 V battery/ Power supply	12 V battery/ Power supply	12 V battery/ Power supply
Minimum water depth	15 cm	40 cm	40 cm
References battery/Power supply	xz490fv003-d-000b / xz490fv003-d-000s	xz490fv002-d-000b / xz490fv002-d-000s	xz490fv003000-d-000b/ xz490fv003000-d-000s

The warranty is 2 years for parts and work in workshop. (Excludes filters and battery).

Non-contractual photos.



The power of a cyclone

Quick Vac' Cyclone



Non-contractual photos.

Technical data

Quick Vac' Cyclone

Dimensions
Suction power
Materials
Cable length
Weight out of water
Pump
Filtration (microns)
Filtration capacity
Autonomy
Minimum water depth
Power supply
References

Quick Vac' Cyclone E



Cleaning up to 300m²
from 0.5 to 1 HP
Thermoplastic / polycarbonate
10 m
35 kg
663 W
Pleated cartridge
3.7m² filtering surface
—
—
220 - 240 V
z289h200400hex

Quick Vac' pump



L.45 x P.112 x H.86 cm
27m³/h
—
15 m
34 kg
Contact us
—
—
230 V
Contact us

Fairlock vacuum head A



48 cm/ 96 cm
—
Plastic
Floating hose (in option)
3,5 kg/ 7 kg
—
—
15 cm
—
z124ffairlock / z124ffairlock96cm
A - **A**

Quick Vac' spa turbo XL B



40 cm
15m³/h
ABS plastic
—
1,4 kg
250 W
50 or 100 μ
About 1 kg of sand
2h
21 cm
12V rechargeable battery
z160hplwrxl



Floating hose F



Diameter 38mm or 50mm.

F 25 m, ø 38 mm
z218h44309-25m
F 25 m, ø 50 mm
z218h44329-25m

Consult us for other lengths

Telescopic handle A



Aluminum with clip and grip.

A 2,4-4,8 m
z218f044030
A 7,5 m reinforced
z218f44004
A 10 m reinforced
z218f44005

Net F



Stainless steel net with ultra resistant mesh.

F Classic net
z218f44647
F Reinforced net
z797fribtb

Non-contractual photos.

Wall brush A



Reinforced curve brush of 45 cm length.

A A clip
z218f44645cl
A Butterfly
z218f44645pp
A Reinforced
z246f814005012

360° brush A



Clip attachments. 360° hard-bristled.

A Brush 30 cm
z181fac88072
A Brush 45 cm
z181fac88757

Clean inaccessible places



SCAN TO WATCH THE VIDEO

line



Telescopic handle from 1.50m to 2.50m

Special air/water line!

COMPLETE LINEO BRUSH

Battery included in the backpack



Battery charger for Lineo M A

Charger 220V / 12V DC.
z702fms1580-2

Head adjustable at 70°



Brushes			Support Pad
Medium Tiled surface	Rigid Painted wood	Nylon For all coatings	
Pad			
Medium Liner/plastic floor	Strip Tiled surface	Buffing Stratified wood	Lustering Stainless steel

Accessories, brushes, pad optional, contact us

Non-contractual photos.

Technical data

line

Brush diameter
Power supply
Telescopic handle
Battery charger
Power/ Autonomy
Weight
Brushing/ Cleaning
Dimensions (WxDxH folded)
References

Lineo M complete **A**



ø 15 cm
12V marine battery
150 to 250 cm
Serial
40 W / 1h30"
2,5 kg
Pad / nylon brush rotating at 70°
17 x 112 x 15 cm
xlineo1200n000

Brush Lineo magic sponge **A**



HEXAGOM Special Lineo is a magic sponge of HIGH DENSITY for water line on motorized brush. HEXAGONE exclusivity. It takes a lot less chemicals. Test it, you will be amazed!

- A** GOM alone z114fgomme
- A** Support PAD z114fpqxlrdisk

Water line cleaning gel **A**



- Can 1 kg z246f783000010
- Can 5 kg z246f783000050
- Can 10 kg z246f783000100
- Can 25 kg z246f783000250

Hexagom, magic sponge **C**

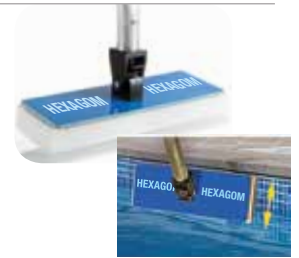

HEXAGOM, the new great multi-surface magic eraser. Effectively clean stains and encrusted dirt on the walls, pool bottom and water line. High density foam compared to most competitors.

- C** Brush head XL z114fpqxl20
- C** Gom XL z114fpqxl60
- C** Gom L z188f250.100.100

Manual cleaning



Hexagun, chlorine gun **F**



Chlorine HEXAGUN is an easy and effective system for cleaning and disinfection. It can be used everywhere and on all surfaces that can withstand water.

- F** Hexagun 70 PPM z115fsws-sp-70
- F** Hexagun 250 PPM z115fsws-sp-250
- F** Pack 8 tablets z115fswst-01-08

Flexi pro black **F**



Expandable watering hose, ø22 mm, anti-twisting.

- F** 15 m z188f475.500.015
- F** 30 m z188f475.500.030

2 products cleaning station **F**



Anti-shock pistol type dinga **F**
Multijet gun.
Locking trap.
z153f180691

Ideal for daily cleaning of floors and surfaces. Easy to install, connects directly to a faucet, works without electricity. Allows efficient mixing thanks to 14 colour calibrated nozzles.

- F** Wall station z237fcep2150apa00000
- F** Trolley for proposed model z237flb99.chm.sb10

Other models, contact us

Cleaning trolley TM 2815W **F**



Clean water bucket 28 liters.
Dirty water bucket 15 liters.
Dimensions: H.82 x W.41 x D.125 cm.

z236f629196

Other models, contact us

Non-contractual photos.

Ideal for cleaning floors in pools



Removable 24 V rechargeable battery

Foldable, easy to transport

Adjustable washing brush and disk

Delivered with battery + charger + brush



Non-contractual photos.

Scrubbers

Brushes option
z236f606108



Working width	ø 35 cm
Power supply	220-240 V / 50-60 Hz
Power/ Cleaning	- / 150 rounds/min
Battery charger/ autonomy	—
Weight	18,5 kg
Area performance	1100 m ² /h
Brushing	Nylon pad or brush
Water tanks	10 L
References	z236f704490 Without brushes

Working width	ø 40 cm
Power supply	12 V
Power/ Cleaning	250 W/ 150 rounds/min.
Battery charger/ autonomy	Included/ 50 min.
Weight	27 kg
Area performance	1400 m ² /h
Brushing	Nylon pad or brush
Water tanks	10 L
References	z275h27-400-40601244

Working width	ø 40 cm
Power supply	24 V
Power/ Cleaning	400 W/ 150 rounds/min.
Battery charger/ autonomy	Included/ 35 - 45 min.
Weight	40 kg
Area performance	1400 m ² /h
Brushing	Nylon pad or brush
Water tanks	18/ 18 L
References	z236f903966

Working width	ø 45 cm
Power supply	24 V
Power/ Cleaning	400 W/ 100 rounds/min.
Battery charger/ autonomy	Included/ 2h.
Weight	90 kg
Area performance	1600 m ² /h
Brushing	Nylon pad or brush
Water tanks	30/ 30 L
References	z236f903608

Weight	7.1 kg.
Power	1200 W.
Air volume	40 liters / second.
Clean water bucket	9L.
Dimensions :	35,5 x 35,5 x 51 cm
References	z236f838129



SCAN TO WATCH THE VIDEO

Steam rotobrushes



Brushes width	280 mm
Power supply	220-240 V / 50-60 Hz
Power / brushing speed	1000 W/ 650-750 rpm
Weight	27 kg
Surface yield	180 m ² /h
Brushes	2 brushes ø 10 cm nylon
Detergent / Recovery Tank	4,2/ 2,8 L
Dimensions (WxDxH)	34 x 43 x 24 cm (excluding handle)
References	z236f340875045

Brushes width	350 mm
Power supply	220-240 V / 50-60 Hz
Power / brushing speed	1000 W/ 650-750 rpm
Weight	27 kg
Surface yield	180 m ² /h
Brushes	2 brushes ø 10 cm nylon
Detergent / Recovery Tank	6/ 3,5 L
Dimensions (WxDxH)	42 x 43 x 24 cm (excluding handle)
References	z236f420875045

Brushes width	320 mm
Power supply	Lithium battery 36 V 50-60 Hz
Power / brushing speed	350 W/ 500 rpm
Weight	15 kg (empty)
Surface yield	1500 m ²
Brushes	2 brushes ø 10 cm nylon
Detergent / Recovery Tank	4/ 6 L
Dimensions (WxDxH)	41 x 49 x 112 cm (with handle)
References	z236f381303601

Roller brushes optional



Several models, consult us

A maintenance contract is possible when purchasing equipment. Non-contractual photos.



To choose well...

- Single pool or multi basins
- Autonomous or accompanied
- Mobile or fixed
- Frequency of use

Intensive use

Regular use

Chairs

Mobile



PAGE 42

unikart
design



PAGE 44

unikart
classic



PAGE 46-47

Non-contractual photos.

The access for all everywhere

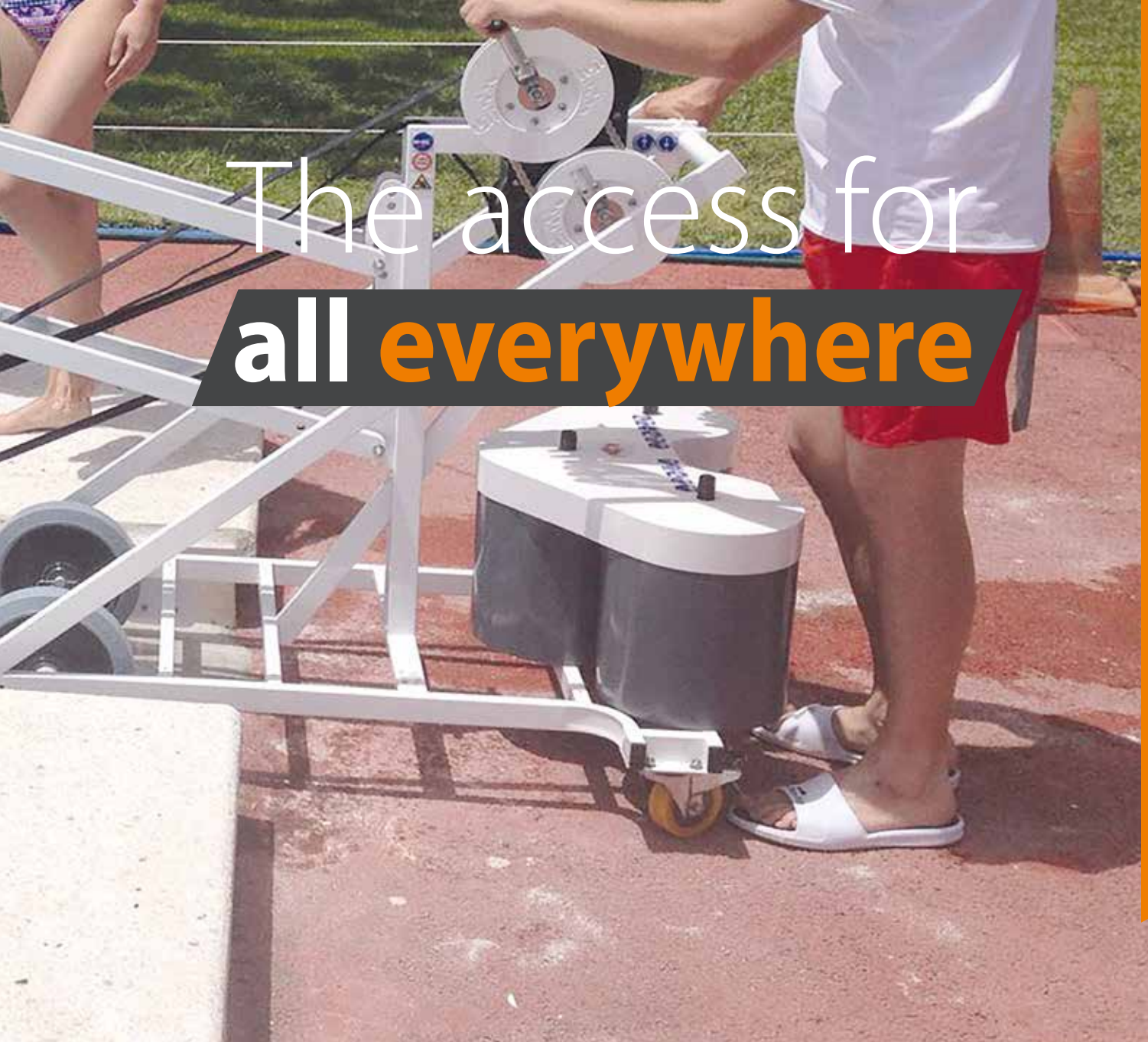

Disabled access

Hydraulic



PAGE 48 and 51 **injet**

Hoist



PAGE 50 **infix**

Motorized



PAGE 47 and 51 **SRSmith**

Fixed

Non-contractual photos.



Accessible pool



SCAN TO WATCH
THE VIDEO

UNIKART DESIGN 300



Motorized version
available in April
2019

Adjustable
counterweight

360° swivel
wheels with
brake

Adjustable
headrest

Adjustable
armrests

136
MAXI

Delivered with
brake carpet
for basin edge



Non-contractual photos.

**WORLD
PATENT**



Simplified pools disabled access

Approved by Apave

No engine, immediate availability

Pantograph system for perfect security

Complies with standard No.2006/42/CE



**No.1
in France!**

**UNIQUE
SYSTEM**

unikart
design

Mobile

**REGULAR
USE**

**INTENSIVE
USE**

Technical data

Max lifting load
Weight with counterweight
Power supply
Rear wheels
Front wheels
Dimensions (WxDxH)
Trolley/ Seat
System
The lowest seat position
References

Unikart Design manual 300 A

Up to 136 kg
365 kg
No
Swivel braked
Solid wheels
80 x 120 x 170 cm
Painted stainless steel/ Polypropylene
Pantograph (double winch)
90 cm
xuni310n000

Unikart Design motorized 300 XD A

Up to 136 kg
365 kg
24V battery
Swivel braked
Solid wheels
80 x 120 x 170 cm
Painted stainless steel/ Polypropylene
Pantograph (motorized actuator)
75 cm
xunim31n000



Tetraplegia harness option A

Fasteners for head, thorax, wrists, hips
qqk001n000

Non-contractual photos.

unikart
classic



SCAN TO WATCH
THE VIDEO



136
MAXI

3
possible
choices



NEW!
Waterproof
remote control

REGULAR
USE

UNIKART winch
MANUAL



INTENSIVE
USE

UNIKART XD on
BATTERY



INTENSIVE
USE

UNIKART actuator via
24V POWER



Non-contractual photos.

**WORLD
PATENT**



Access for all, without **installation**

Disabled access



Technical data

Unikart Classic Manual

Unikart Classic Motorized XD

Unikart Classic Motorized with plug

unikart
classic

Mobile

Max lifting load
Weight with counterweight
Power supply
Rear wheels
Front wheels
Dimensions (WxDxH)
Trolley/ Seat
System
The lowest seat position
Warranty
References



Up to 136 kg
260 kg
No
Swivel braked
Solid wheels
80 x 120 x 170 cm
Painted stainless steel/ Polypropylene
Pantograph (double winch)
80 cm
2 years
xunin008



Up to 136 kg
260 kg
24V battery
Swivel braked
Solid wheels
80 x 120 x 170 cm
Painted stainless steel/ Polypropylene
Pantograph (motorized actuator)
65 cm
2 years
xunimpn000

NEW!



Up to 136 kg
260 kg
110 v-240 v / 24 vdc
Swivel braked
Solid wheels
80 x 120 x 170 cm
Painted stainless steel/ Polypropylene
Pantograph (motorized actuator)
65 cm
2 years
xunimpn000s

Non-contractual photos.



A product for every need

Perfect for WC PRM

Technical data

Wheelchair Unikart 50 **D**

Wheelchair Unikart 100 **D**

Wheelchair Unikart 200 **F**

PRM wall panic button **A**

Wheelchair

Floating wheels!



Use
Max lifting load
Weight
Power supply
Rear wheels
Front wheels
Dimensions (WxDxH)
Structure / Seat
References

Occasional
Up to 130 kg
25 kg
None
Inflatables
—
100 x 72,3 x 110 cm
Stainless steel / rigid shell
xuni050n000

Occasional
Up to 100 kg
9 kg
None
Inflatables
—
97 x 93 x 93 cm
Stainless steel / polyester fabric
xuni100n000

Regular
Up to 130 kg
14 kg
None
Braked
Solid
126 x 67 x 40 cm
Aluminum / Foam
xuni200n000

3.2 V battery power supply.
IP 65 protection.
Range 150 m. Waterproof.
Autonomy 18 months.
Dimensions :
100 x 65 x 40 mm.

egs002n001

Non-contractual photos.

Mobile

Function
Max lifting load
Weight
Power supply
Rear wheels
Front wheels
Dimensions (WxDxH)
Trolley/ Seat
System
Seat course
References

Motorized descent design

Up to 136 kg
140 kg
2 batteries 2x18A
2
2
125 x 64 x 151 cm
Aluminum/ stainless steel
Motorized
112 cm
z189fi-swim

Self-propelled / Motorized descent

Up to 145 kg
260 kg
24V battery
2
2
70 x 70 x 170 cm
Stainless steel
Motorized
150 cm
z136fpp(01t)

Motorized rotation and descent

Up to 136 kg
457 kg
24V battery
2
2
72 x 249 x 168 cm
Aluminum/ stainless steel / rotomolded
Motorized
138 cm
z797f202-0000eu

AUTONOMOUS!

**Spa version
page 89**



136
MAXI



145
MAXI



136
MAXI



Disabled access

Wheelchair

Use
Max lifting load
Weight
Power supply
Rear wheels
Front wheels
Dimensions (WxDxH)
Structure / Seat
References



113
MAXI

Regular
Up to 113 kg
27 kg
None
Inflatable ø41 cm
1
107 x 152 x 127 cm
Aluminum - Stainless steel/ Fabric
z350fwaterwheels



130
MAXI

Regular
Up to 130 kg
22 kg
None
2 large
2 small
71 x 95 x 97 cm
Synthetic
z842f570800



150
MAXI

Intensive
Up to 150 kg
20 kg
None
2
2
67 x 82 x 105 cm
100% thermoplastic
z200f715025

**Special
shower
and WC!**



Dimensions (WxDxH) :
67 x 70 x 118 cm

ka0292n000

Non-contractual photos.



Autonomous use



SCAN TO WATCH
THE VIDEO

unijet

Fixed but
mobile!

UNIJET HYDRAULIC ELEVATOR

Autonomous
descent and
ascent

180°

Rigid shell
seat





Autonomous control
handle, minimum
pressure 3 bar

Footrest
optional

Safety wheel
in the ground

120
MAXI

How to install the chemical dowel in 5 steps:

-  1. Drill and clean the hole (Diameter 10 mm) at least 40 cm from the edge.
-  2. Insert the resin bulb.
-  3. Push the bit with the tip attached to the drill. (No hammer).
-  4. Clean excess resin.
-  5. Plate and tighten. Allow to dry for 1 hour before use.



WARRANTY
2
YEARS



Non-contractual photos.



The seat rotates 180° on its axis

Unijet model approved by Apave

Works with water force in piston

Ideal for infinity pool

Complies with legal obligation No 2006/42/CE



unijet

Disabled access

Fixed

To optimize the location of your Unijet, please contact us



Technical data

Direction and degree of rotation

Max lifting load	Up to 120 kg
Weight	55 kg
Minimum pressure	3 bars minimum (city water)
Power supply	Hydraulic
Structure / Seat	316L painted stainless steel / Rigid shell
Dimensions (WxDxH)	70 x 70 x 170 cm
Seat course	120 cm
Pool depth	Minimum 1m
Fixation	Coring (chemical anchor provided)
References	xujetn001

Removable footrest option **A**

References

Unijet elevator **A**

Right 180°

Max lifting load	Up to 120 kg
Weight	55 kg
Minimum pressure	3 bars minimum (city water)
Power supply	Hydraulic
Structure / Seat	316L painted stainless steel / Rigid shell
Dimensions (WxDxH)	70 x 70 x 170 cm
Seat course	120 cm
Pool depth	Minimum 1m
Fixation	Coring (chemical anchor provided)
References	xujetn001

kj0015n000

Unijet elevator **A**

Left 150°

Max lifting load	Up to 120 kg
Weight	55 kg
Minimum pressure	3 bars minimum (city water)
Power supply	Hydraulic
Structure / Seat	316L painted stainless steel / Rigid shell
Dimensions (WxDxH)	70 x 70 x 170 cm
Seat course	120 cm
Pool depth	Minimum 1m
Fixation	Coring (chemical anchor provided)
References	xujettppn001

kj0022n000

Non-contractual photos.

unifix



ECO model!

UNIFIX LIFT ACTUATOR

150
MAXI



Floor fixation by ø50mm coring or attachment plate

NEW! Manual or motorized actuator



Hard seat optional

Hard seat optional
Stainless steel structure, plastic shell
References z190fsp.04

REGULAR USE

UNIFIX with actuator **MANUAL**

INTENSIVE USE

UNIFIX XD on **BATTERY**

INTENSIVE USE

UNIFIX with motorized actuator **AUTONOMOUS**



Non-contractual photos.

For swimming pool



and Spa

Technical data

Manual Unifix D

Motorized Unifix XD F

Autonomous Unifix F



Fixed

- Use
- Max lifting load
- Weight
- Power supply
- Dimensions (WxDxH)
- Trolley/ Seat
- System
- Seat course
- References
- References
- References

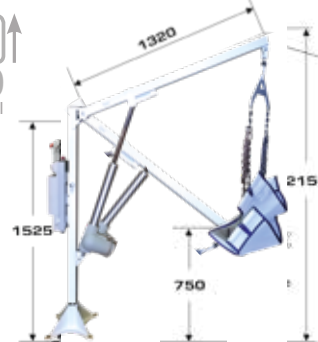

AUTONOMOUS!



Regular

Up to 150 kg

50 kg

None

137 x 30 x 141 cm

Galvanized steel/ hammock or seat

Manual

130 cm

Attachment plate z190fph01-3

Gallows alone

Coring z190fph01-2

Gallows alone

z190fha02-1

Hammock optional

NEW!

Intensive

Up to 150 kg

60 kg

2 batteries

132 x 30 x 152,5 cm

Galvanized steel/ hammock or seat

Motorized

140 cm

Attachment plate z190fpv01-3

Gallows alone

Coring z190fpv01-2

Gallows alone

z190fha02-1

Hammock optional

Autonomous

Up to 136 kg

60 kg

24 volts battery

211 x 47 x 140 cm

Aluminum/ stainless steel / rotomolded

Electric actuator

122 cm

z797f310-0000eu

Complete

Spa version P.89

z797f310-0000ceu

Big height

Technical data

Autonomous elevator ■

Autonomous platform ■

Stainless steel staircase ■

Fixed

- Use
- Max lifting load
- Weight
- Power supply
- Dimensions (WxDxH)
- Materials
- System
- Seat course
- References



AUTONOMOUS!

Autonomous

Up to 120 kg

—

Hydraulic

77 x 103 x 289 cm

Stainless steel

Hydraulic

117 cm

Contact us



Autonomous

Up to 150 kg

—

Hydraulic

Stainless steel 316L

Hydraulic

—

Contact us



Regular

—

—

Battery

—

Stainless steel

—

—

Contact us

Non-contractual photos.

Hexagone, the largest range of disabili

Technical data

Unikart Classic Manual **A**

Unikart Classic Motorized XD **A**

Unikart Classic Motorized with plug **A**

Unikart Design manual 300 **A**



No.1 IN FRANCE

Use
Max lifting load
Weight
Rear wheels
Front wheels
Structure
Seat
System
The lowest seat position
Power supply
Dimensions (W x D x H)
Page number

Regular
136 kg
260 kg (with counterweight)
Swivel braked
Solid wheels
Painted stainless steel
Polypropylene
Pantograph (double winch)
80 cm
None
80 x 120 x 170 cm
44

Intensive
136 kg
260 kg (with counterweight)
Swivel braked
Solid wheels
Painted stainless steel
Polypropylene
Pantograph (motorized actuator)
55 cm
24V battery
80 x 120 x 170 cm
44

Intensive
136 kg
260 kg (with counterweight)
Swivel braked
Solid wheels
Painted stainless steel
Polypropylene
Pantograph (motorized actuator)
55 cm
110 v-240 v / 24 vdc
80 x 120 x 170 cm
44

Regular
136 kg
365 kg (with counterweight)
Swivel braked
Solid wheels
Painted stainless steel
Polypropylene
Pantograph (double winch)
90 cm
None
80 x 120 x 170 cm
42

FIXED DISABLED ACCESS

Technical data

Unijet elevator **A**

Manual Unifix **F**

Motorized Unifix XD **F**

Autonomous Unifix **F**



Spa version P.89

Use
Max lifting load
Weight
Rear wheels
Front wheels
Structure
Seat
System
Seat course
Power supply
Dimensions (W x D x H)
Page number

Autonomous
120 kg
55 kg
2
—
316L painted stainless steel
Rigid shell
Hydraulic
120 cm
3 bars minimum (city water)
70 x 70 x 170 cm
48

Regular
150 kg
50 kg
—
—
Galvanized steel
Hammock or seat
Manual
130 cm
None
137 x 30 x 141 cm
50

Intensive
150 kg
60 kg
—
—
Galvanized steel
Hammock or seat
Motorized
140 cm
2 batteries
132 x 30 x 152,5 cm
50

Autonomous
136 kg
60 kg
—
—
Aluminium/ Galvanized steel
Rotomolded
Electric actuator
122 cm
24V battery
211 x 47 x 140 cm
51

The warranty is 2 years for parts and work and on-site visits. Excludes consumables. Non-contractual photos.

ed access equipment on the market

MOBILE DISABLED ACCESS

Unikart Design motorized **300 XD A**



Intensive
136 kg
365 kg (with counterweight)
Swivel braked
Solid wheels
Painted stainless steel
Polypropylene
Pantograph (motorized actuator)
65 cm
24V battery
80 x 120 x 170 cm
42

Unikart Swim **D**



Intensive
136 kg
140 kg
2
2
Aluminum/ stainless steel
—
Motorized
62 cm
2 batteries 2x18A
125 x 64 x 151 cm
47

Unikart Pool lift **D**



Intensive
145 kg
260 kg
2
2
Stainless steel
—
Motorized
90 cm
24V battery
70 x 70 x 170 cm
47

Unikart Pal lift 360° **D**

Spa version P.89



Autonomous
136 kg
457 kg
2
2
Aluminum/ stainless steel
Rotomolded
Motorized
79,3 cm
24V battery
72 x 249 x 168 cm
47

Disabled access

CHAIRS FOR POOL ACCESS, SHOWER, SWIMMING

Wheelchair Unikart **50 D**



Occasional
130 kg
25 kg
Inflatables
—
Inox marine
Rigid shell
—
—
—
100 x 72,3 x 110 cm
46

Wheelchair Unikart **100 D**



Occasional
100 kg
9 kg
Inflatables
—
Inox marine
Polyester fabric
—
—
—
97 x 93 x 93 cm
46

Wheelchair Unikart **200 F**



Regular
130 kg
14 kg
Braked
Solid
Aluminium
Foam
—
—
—
126 x 67 x 40 cm
46

Wheelchair Uniblue **F**



Regular
130 kg
22 kg
2 large
2 small
Synthetic
Synthetic
—
—
—
71 x 95 x 97 cm
47

Shower wheelchair **F**



Intensive
150 kg
20 kg
2
2
100% thermoplastic
100% thermoplastic
—
—
—
67 x 82 x 105 cm
47

Bathing wheelchair **F**



Regular
113 kg
27 kg
Inflatables ø41 cm
1
Aluminium-Stainless steel
Fabric
—
—
—
107 x 152 x 127 cm
47

The warranty is 2 years for parts and work and on-site visits. Excludes consumables. Non-contractual photos.

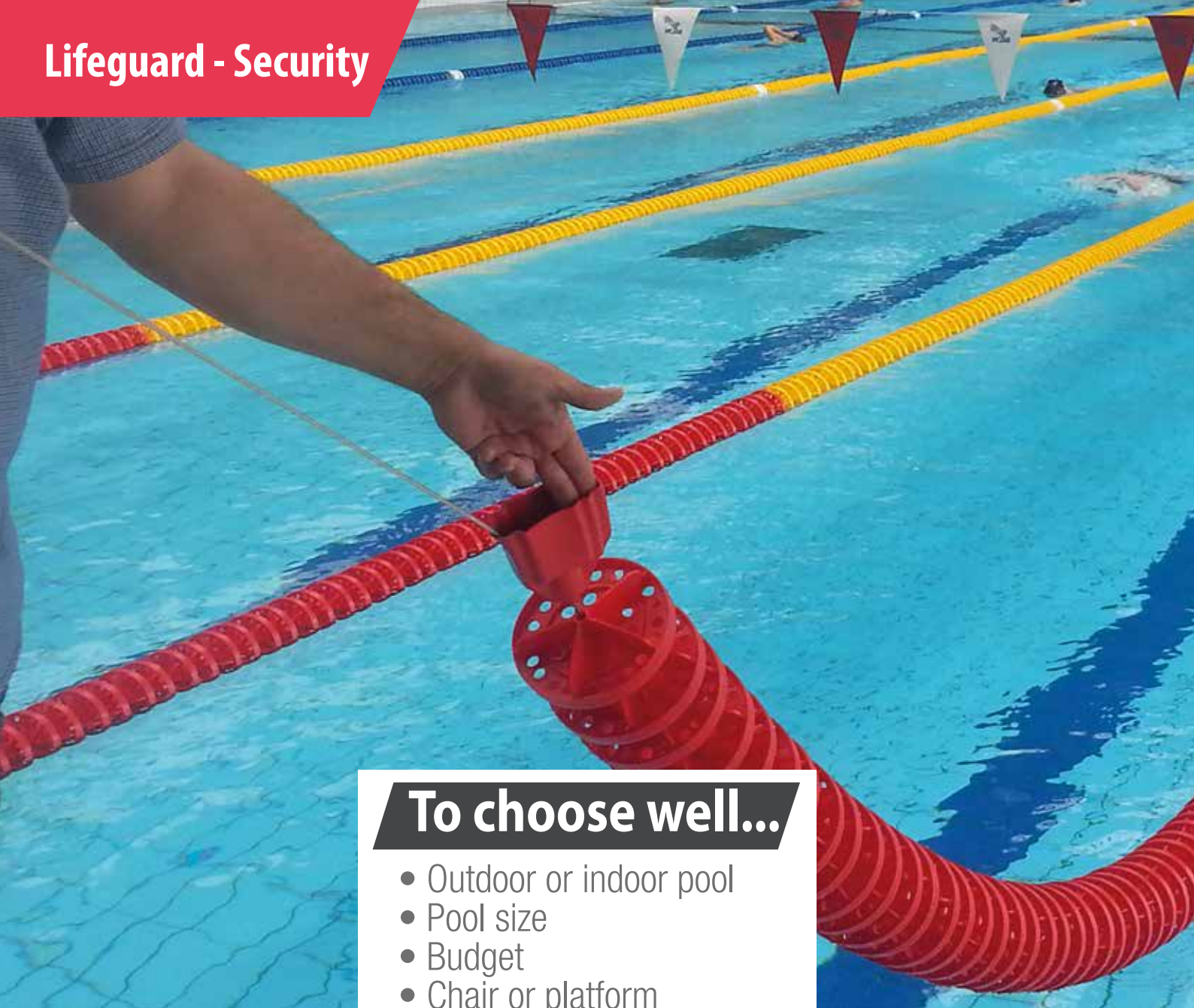

To choose well...

- Outdoor or indoor pool
- Pool size
- Budget
- Chair or platform

Chairs



PAGE 56

**HEXA
CHAIR**

Platforms



PAGE 58

MALIBU

Security



PAGE 60

**SECUR
SPARTEL
RELIS**

Non-contractual photos.

Everything for the **Lifeguard**



Swimming lanes



PAGE 64

 Hexa Star

Starting blocks



PAGE 67

Games



PAGE 67

Non-contractual photos.



A comfortably seated lifeguard is happy



- Official chair of the American rescuers
- Robust with double anti-slip step
- Ideal for back, comfortable seat
- Parasol and drink holder
- 4 available sizes

Non-contractual photos.

Technical data

1-Step Hexa Chair **F**

2-Steps Hexa Chair **F**

3-Steps Hexa Chair **F**

4-Steps Hexa Chair **F**

**HEXA
CHAIR**

**Premium
Chairs**

Weight
Seat height
Dimensions (WxDxH)
Material
References



35 kg
80 cm
74 x 84 x 140 cm
Recycled polypropylene
z093flg505w



50 kg
100 cm
76 x 104 x 155 cm
Recycled polypropylene
z093flg510w



70 kg
127 cm
76 x 109 x 180 cm
Recycled polypropylene
z093flg515w



86 kg
152 cm
168 x 125 x 210 cm
Recycled polypropylene
z093flg517w



Lifeguard

Technical data

4-Steps Aluminum Chair **F**

5-Steps Aluminum Chair **F**

6-Steps Aluminum Chair **F**

**HEXA
CHAIR**

**Optima
Chairs**

Weight
Seat height
Seat
Material
References



15 kg
2 m
PVC
Aluminium
z569h505-4



20 kg
2,18 m
PVC
Aluminium
z569h505-5



25 kg
2,36 m
PVC
Aluminium
z569f505



Lifeguard parasol **F**
 • Special 100% acrylic fabric.
 • ø 180 cm, height 140 cm
 • Aluminium handle ø 40 mm
F Without logo
 z241f90/10d180-11
F With Hexagone's logo
 z241h90/10d180-11-n001

Non-contractual photos.



The new surveillance tower



MALIBU



2 umbrella storage supports

Buoy holder hook

360° swivel seat, high visibility

Parasol supports

8 feet of stability

3 anti-slip steps



Non-contractual photos.

For aqua park, beach, camping, multi pools

Robust, made of recycled plastic

Can be used sitting or standing

Swivel chair with 360° viewing

Holders for parasol, bottle and buoy







Technical data

Malibu Platform **D**

Friedel Platform **D**

Friedel Platform + **D**

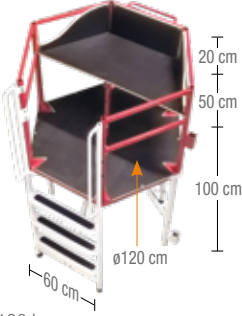
Hexa Chair Platform **D**

Technical data	MALIBU	FRIEDEL	FRIEDEL	Hexa Chair Platform D
 HDPE HDPE RECYCLING PLASTIC				
Load max.	180 kg	180 kg	180 kg	180 kg
Weight	75 kg	60 kg	80 kg	70 kg
Seat height	150 cm	150 cm	150 cm	150 cm
Dimensions (WxDxH)	137 x 125 x 170 cm	120 x 170 x 170 cm	170 x 170 x 220 cm	121 x 150 x 177 cm
Material	Recycled polypropylene	Stainless steel/ marine wood	Stainless steel/ marine wood	Recycled polypropylene
References	z093flgpf50w	i00001n000	Contact us	z093fmlg520w

Non-contractual photos.

Internal communication system

secu-relay*



HEXAGONE MANUFACTURE



A «secu-relay» radio kit for an emergency warning throughout the establishment, between you and the users.



**Radio
panic
button**

Configure your alert system on page 62.

Wireless alert communication system

Button IP65 or anti-panic radio control IP68

Reception box with light and sound signal

Easy and fast installation

Protected by international patent

*Information and communication system exclusively.
Cannot replace alarms or any other means of surveillance.

Non-contractual photos.



Technical data

Standard wall panic button **A**

Special sauna panic button **A**

User buttons

- Power supply
- Protection
- Range
- Waterproof
- Autonomy
- Dimensions
- References



3.2 V battery
 IP 65
 150 m
 Yes
 18 months, 1 / 2AA lithium battery, 3.6V
 100 x 65 x 40 mm
 egs002n001

Ideal for unsupervised zones



3.2 V battery
 IP 65
 150 m
 Yes
 18 months, 1 / 2AA lithium battery, 3.6V
 100 x 65 x 40 mm
 Inside button + outside button
 egs004n000 + egs005n001

Withstands up to 110°!

Technical data

Panic button with announcement **A**

Multi-zone radio control **A**

Pool Team Buttons

- Power supply
- Protection
- Range
- Waterproof
- Autonomy
- Dimensions
- References



3.2 V battery
 IP 65
 150 m
 Yes
 18 months, 1 / 2AA lithium battery, 3.6V
 100 x 65 x 40 mm
 egs003n001

Fixed for lifeguards, cashiers



3.2 V battery
 IP 68
 150 m
 Yes
 18 months, 1 / 2AA lithium battery, 3.6V
 118 x 68 x 37 mm
 egs001n000

Mobile for cleaners, technicians

Technical data

Spartel LED box with speaker **A**

Spartel signal repeater **A**

Central reception box

- Power supply
- Protection
- Range
- Waterproof
- Optional power supply
- Dimensions
- Reference



220 V socket
 IP 66
 150 m
 Yes
 Solar panels
 254 x 180 x 90 mm
 eks001n000

Displays the triggered button area



220 V socket
 IP 66
 100 m
 Yes
 -
 180 x 94 x 60 cm
 eks005n000 (simple) - eks006n000 (passing through walls)

Passes through walls!

Non-contractual photos.

Where to install the SPARTEL

EXAMPLES OF POSSIBLE LOCATIONS		POOL 1 (principal)	POOL 2 (padding pool)	POOL 3 (Outside)
EMERGENCY USER SITUATION		ZONE 1	ZONE 2	ZONE 3
Client PANIC button	 PANIC button for SAUNA To warn in a sauna or steam room unsupervised during a malaise...			
	 PANIC button during FALL To warn at the edge of the pool while slipping or falling...			
	 PANIC button for PRMs To warn at the edge of the pool during a PRM access problem...			
	 PANIC button while ISOLATION To warn when a person is in an unattended, isolated area...			
EMERGENCY SITUATION FOR SWIMMING POOL TEAM		ZONE 1	ZONE 2	ZONE 3
Staff ALERT button	 RESCUE ALERT To warn at the edge of the pool during a rescue procedure...		With personalized announcement 	
	 INCIVILITY ALERT To warn about impolite behavior and ask for help...			
	 CASH DESK ALERT To warn at the cash desk or at the reception during the attack...			
	 TECHNICAL ALERT To warn in the technical room in case of fall or intoxication...			
CENTRAL SPEAKER & ZONE DISPLAY		ZONE 1	ZONE 2	ZONE 3
	1 light and sound reception box to install where you want to be warned. (The box displays the number of the panic button that has just been triggered and emits sounds to warn the entire establishment).			

Non-contractual photos.

secu-relay system?



CLOAKROOM 1	CLOAKROOM 2	CASH DESK	SAUNA WELLNESS	TECHNICAL AREA	OFFICE
ZONE 4	ZONE 5	ZONE 6	ZONE 7	ZONE 8	ZONE 9
ZONE 4	ZONE 5	ZONE 6	ZONE 7	ZONE 8	ZONE 9
ZONE 4	ZONE 5	ZONE 6	ZONE 7	ZONE 8	ZONE 9

Non-contractual photos.

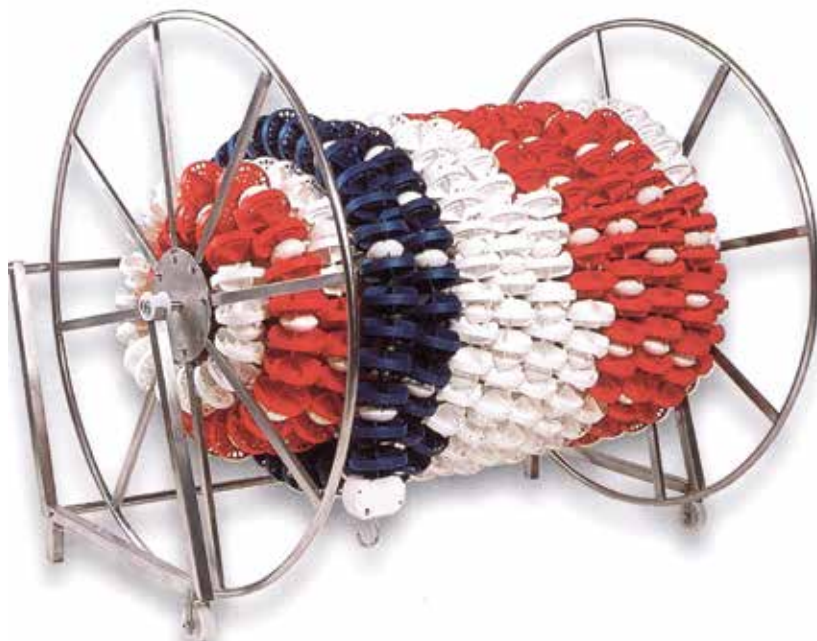

**FINA
rules!**

**LANE
ROPES**

5 colours: blue, red, white, green and yellow

3 diameters of asymmetric disks in PP

Lanes of separation, training or competition

Mounted on plastic coated stainless steel cable AISI316, \varnothing 6 mm

High resistance to chemical agents & weathering

HEXA STAR M

\varnothing 85

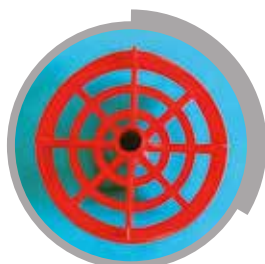

\varnothing 85 mm

HEXA STAR L

\varnothing 120

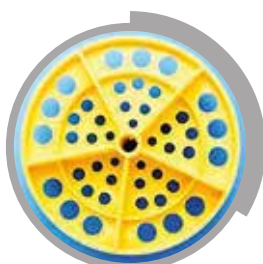

\varnothing 120 mm

HEXA STAR XL

\varnothing 150



\varnothing 150 mm



Conical stainless steel anti-tear spring



Double threaded tensioner



Stainless steel rope



Tensioner jack

Non-contractual photos.

Technical data

Hexa Star **M D**

Hexa Star **L D**

Hexa Star **XL D**

The lane ropes are delivered without tensioner



Disc diameter

ø 85 mm

ø 120 mm

ø 150 mm

Line length

25 and 50 m

25 and 50 m

25 and 50 m

Floats

In HDPE (7 per meter)

In HDPE (6 per meter)

In HDPE (6 per meter)

Colours

Blue, red, yellow white, green

Blue, red, yellow white, green

Blue, red, yellow white, green

Material

Polypropylene

Polypropylene

Polypropylene

Cable

Stainless steel ø 6 mm (plastic coated)

Stainless steel ø 6 mm (plastic coated)

Stainless steel ø 6 mm (plastic coated)

References 25 m

D z113fgr.31-25mstd

D z113fgr.15-25m-std

D z113fgr.24-25m-std

References 50 m

D z113fgr.31-50mstd

D z113fgr.15-50m-std

D z113fgr.24-50m-std



Regulatory
compliant

Lifeguard



Equipment



Lane storage rolling reels B

Stainless steel. Casters with brake.
L. 1,30m (4 lines 25m or 2 lines 50m).
Hexastar M or L z115fgr9
L. 1,50m (4 lines 25m or 2 lines 50m).
Hexastar XL z115fgr23



Storage bag F

Swimming lane ropes storage bag.
z354f3300093614



Swim lane caddy F

Ideal for the sharp pool edge, ensuring safe removal of swimming lanes.
z197f10111021



Swimming lap counter C

Helps swimmers count lengths for competitions. Stainless steel frame. Tables with two-colour numbers are easy to use.
z113fgr.38

Non-contractual photos.



A swimming pool is a game

Learning

Aquatic cage **F**

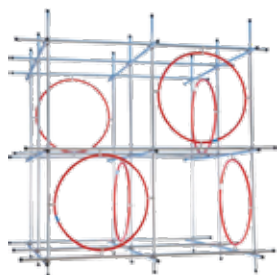

Marine quality painted aluminum.
Various models are available.

F 1,5 x 1,5 m

z569f5530

F 2 x 2 m

z569f606

Reinforced belt **F**



Belt of 4 or 5 floats.
Stainless steel buckle.

F 4 floats

z569f6924

F 5 floats

z569f6925

Swim board **F**



Dimensions : L.40 x D.28 cm.
Thickness 4 cm.

F Without handholds

z569f6940

F With handholds

z569f6949

Pool Noodles **F**



8 cm. For baby, aqua gym, learning,
relaxation. Lot of 10.

F Round

z354f72411

F Square

z354f7240

Pull-buoy **F**



140 mm thick.
A figure-eight form.
Antimicrobial, antibacterial.

z569f4291

Baby floating mats with holes **F**



Foam with a density of 40 kg/m³.

100 x 50 x 1,5 cm

z354f7160

200 x 100 x 4,5 cm

z354f7081

Swim Paddles **F**



Flat training paddle with elastic bands.
20 x 13 cm. The pair.

Junior Paddle

z569f1995

Senior Paddle

z569f1996

Turtle Pack for teaching kids to swim **F**



Innovative
swimming
aid

For children from 3 to 6 years weighing 15 to
30 kg. Do not protect against drowning. EVA
foam shell and neoprene vest. 31 x 25 x 12
cm. Weight 860 gr. Complies with EN71 1/2/3
and EN13138 safety standards.

Contact us

Non-contractual photos.

Water games

Water Volleyball **A**



Aluminum.
Width 400 cm.
z297f96008-1

Floating basketball hoop **A**



Stainless steel.
Fixed.
z297f96007-1

Basketball net **A**



Made of stainless PVC.
With anchor.
z297f96007-2

Water Polo Cage **F**



Stainless steel.
Dimensions : 180 x 90 x 100 cm.
z297f96012

Water slides

Optima Water Slide **F**



Fiberglass.
Dimensions : 233 x 80 x 55 cm.
Weight : contact us.
z297f96056

Water Slide "Elephant" **F**



Fiberglass and 316Ti stainless steel.
Dimensions : 220 x 100 x 125 cm.
Weight: about 160 kg.
z252hslsdssdmb

Compact Water Slide **F**



Fiberglass and 316Ti stainless steel.
Dimensions : 80 x 170 x 230 cm.
Perfect for limited space (130 cm).
z252hslsd55cmp

Water Slide "Rainbow" **F**



Fiberglass and 316Ti stainless steel.
Dimensions : 250 x 65 x 130 cm.
Weight: about 140 kg.
z252hslsdfgrmb

Starting blocks

Complies with FINA standards. Supports a weight up to 500 kg.

Low starting block Nautilus **F**



Starting block with adjustable Fast-Jump system, made of AISI316 stainless steel painted in cream colour and 50x70 cm anti-slip surface in PE-HD.
Base 33x33 cm z113fgr.100

Low starting block Nassau **F**



Starting block with adjustable Fast-Jump system, made of AISI316 stainless steel painted in cream colour and 50x70 cm anti-slip surface in PE-HD.
Base 24x24 cm z113fgr.110

Starting block with step **F**



Electropolished AISI316 stainless steel.
Anti-slip platform.
Height 70 cm.
Adjustable backstroke starting handle.
z113fgr.25

Basic low starting block **F**



Electropolished AISI316 stainless steel.
Anti-slip platform.
Height 40 cm.
Fixed backstroke starting handle.
z113fgr.26

Non-contractual photos.



Hexa Sono



PAGE 70



Design Bike



PAGE 72

Design
Aquafitness



Design multi-activity



PAGE 74

Design
Aquafitness



Non-contractual photos.

The aquatic course

To choose well...

- Fitness with or without courses
- Pool type
- Budget
- Exercise type

Sport Bike



PAGE 76

**SPORT
PREMIUM**

Sport Run & Jump



PAGE 78

**SPORT
PREMIUM**

Aquatic Walks X-Treme Power



PAGE 79



Non-contractual photos.



Special aquafitness sound system



Weatherproof and moisture resistant

Designed for swimming pools, water parks

MP3-USB-SD card reader

Easy to use, reinforced carrying handle

Durable lithium battery

2 outputs for underwater speaker

Bright LED display



Pool oriented speaker

Reinforced carrying handle



4 manoeuvrable wheels



Non-contractual photos.

Technical data



Weight
Power
Range
Dimensions (WxDxH)
Autonomy
Battery
Warranty
References

Hexa Sono Pro ■

Special for pool



35 kg
max.400 W
Standard bluetooth
48 x 30 x 46 cm
Up to 12-14hrs
Lithium Life P04
2 years
Contact us

Hexa Sono Premium D



17 kg
max.125 / 250W
Standard bluetooth
34,5 x 34,3 x 50,5 cm
4 to 6hrs
AC: 220-240Vac 50 / 60Hz
1 year
z310fipS10-250

Hexa Sono Optima D



7 kg
max.140 W
Standard bluetooth
43 x 26 x 54 cm
20hrs (on USB and medium volume setting)
PFC - (Lithium optional)
6 months
z283f954455



Underwater materials



Ideal for synchronized swimming



Underwater loudspeaker ■

Synchro Swim Sound is a built-in underwater speaker. Designed to be installed in the most common submarine spotlights of the PAR 56. 50 Watts RMS / 8 ohms. Insulation class: IP69. Resistant to diving up to 3 meters. Weight: 2.5 Kg. Made of plastic, stainless steel. White colour.

Contact us

Non-contractual photos.



Quality aquafitness



SCAN TO WATCH THE VIDEO

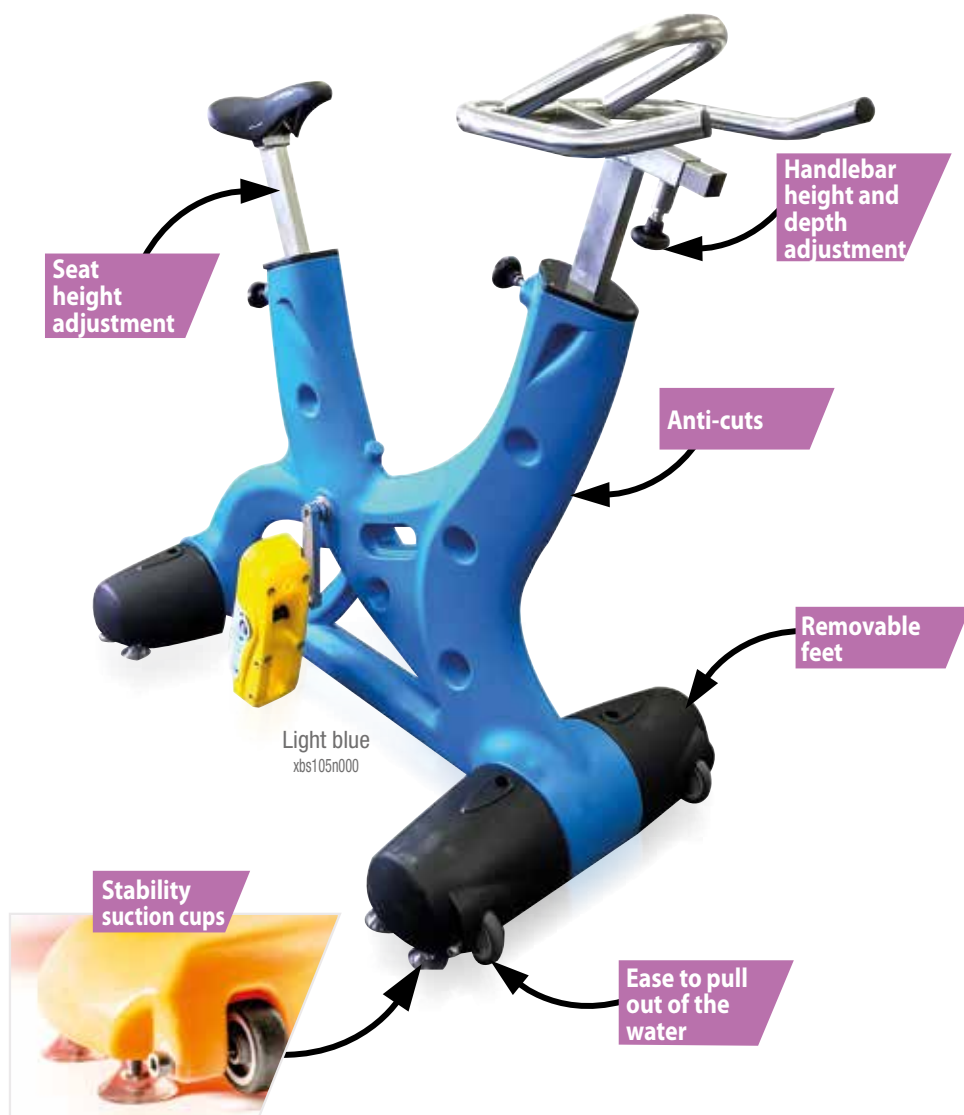

Bike equipment



Comfortable saddle A

Padded foam saddle, adjustable height.

z645h0003



Suction cups A

Transparent semi-rigid suction cup with integrated stainless steel screws.

z645h0004



Pedal with strap A

Ergonomic shape. Ideal for all shoe sizes.

z645h0030n000



Strap F

Reinforced PVC pedal strap.

z645h0016



Aqua Bike Shoes F

Size from 36 to 46.

z183htprt (Size: Consult us)

Non-contractual photos.

Ideal for aquafitness sessions

Multicolour, innovative design

Ergonomic adjustable posture

Increased stability thanks to specific suction cups

Pedal tested for comfort barefoot use



Technical data

Hexa Bike Optima 100 **A**

Hexa Bike Optima 200 **A**

Design
Aquafitness



Weight	14 kg
Material	Polyethylene/ stainless steel
Depth of use	120 - 140 cm
Dimensions	115 x 92 x 66 cm
Suction cup	8
Wheels	2 front
Colours	8
Brake	Without
References	8 colours (please specify)

Weight	16 kg
Material	Polyethylene/ stainless steel
Depth of use	120 - 170 cm
Dimensions	120 x 160 x 66 cm
Suction cup	9
Wheels	2 front
Colours	7
Brake	With
References	7 colours (please specify)

Non-contractual photos.

Sport in water **reinvented**



SCAN TO WATCH
THE VIDEO

Design Aquafitness



Fully
foldable



Easy to pull out
of the water



Stability
suction cups



Handle lock
system
for storage



Non-contractual photos.

Technical data

Hexa Step Trolley **A**

Hexa step **A**

Hexa run **A**

Design
Aquafitness

- Weight
- Material
- Depth of use
- Dimensions
- Suction cup
- Wheels
- Colours
- Brake
- References



- Contact us
- Material
- Depth of use
- Dimensions
- Suction cup
- Wheels
- Colours
- Brake
- References



- Weight
- Material
- Depth of use
- Dimensions
- Suction cup
- Wheels
- Colours
- Brake
- References



- Weight
- Material
- Depth of use
- Dimensions
- Suction cup
- Wheels
- Colours
- Brake
- References



Technical data

Hexa multi exercise **A**

Floating mattress Hexa paddle **F**

Hexa jump Design **A**

Design
Aquafitness

- Weight
- Material
- Depth of use
- Dimensions
- Suction cup
- Wheels
- Colours
- Charge maximum
- References



- Weight
- Material
- Depth of use
- Dimensions
- Suction cup
- Wheels
- Colours
- Charge maximum
- References



- Weight
- Material
- Depth of use
- Dimensions
- Suction cup
- Wheels
- Colours
- Charge maximum
- References



- Weight
- Material
- Depth of use
- Dimensions
- Suction cup
- Wheels
- Colours
- Charge maximum
- References

Non-contractual photos.



The aquabike

SPORT version

SPORT
PREMIUM

SPORT
RESORT

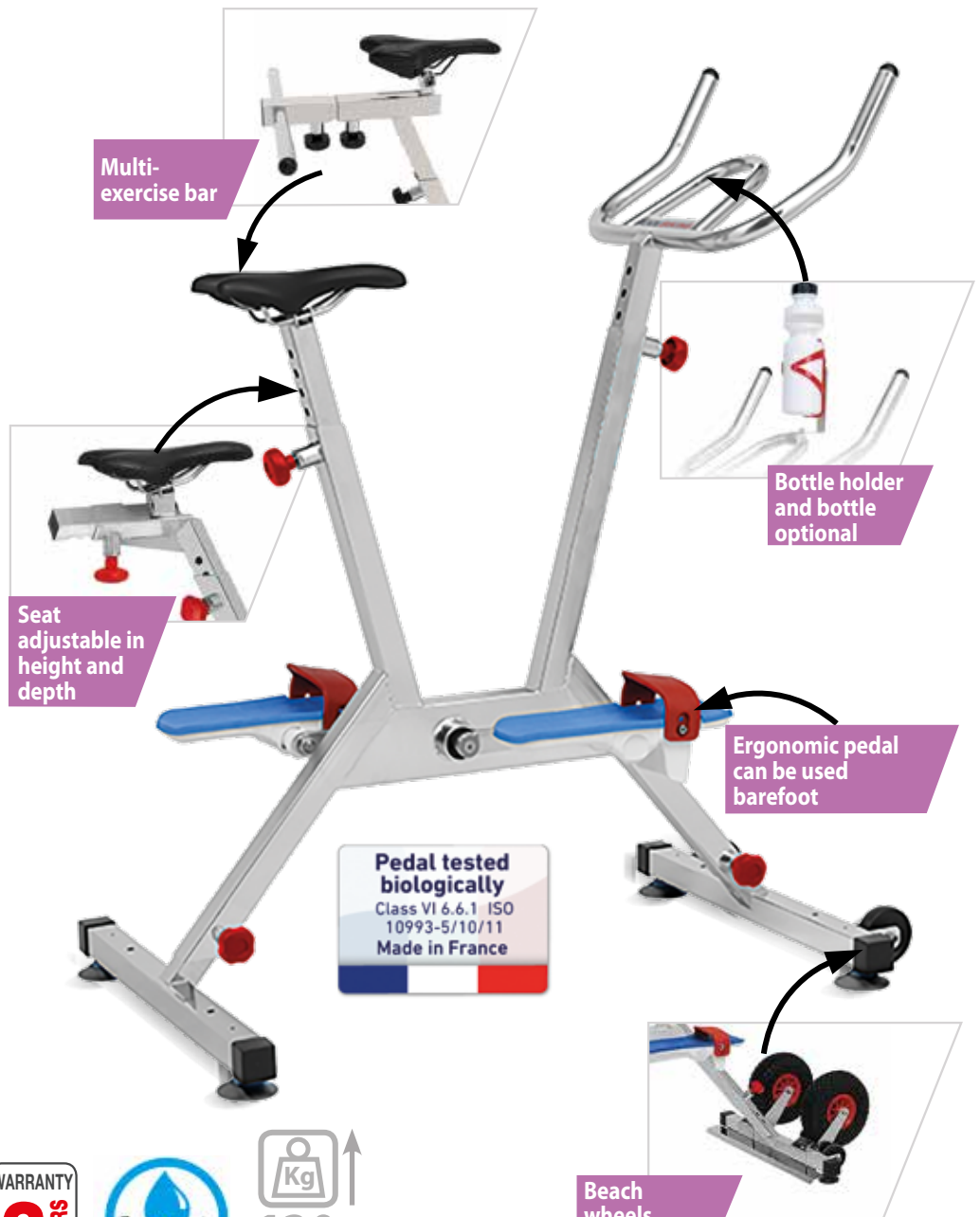

Pedal tested biologically
 Class VI 6.6.1 ISO
 10993-5/10/11
 Made in France

WARRANTY
2 YEARS



120
 MAXI

Non-contractual photos.

Technical data

**SPORT
PREMIUM**

Weight
Material
Depth of use
Dimensions
Suction cup
Wheels
Brake
References

Hexa Bike One 100 **A**



15,2 kg
Stainless steel 316 L
110 - 150 cm
84 x 60,4 x 120 cm
4
2 front
Without
z247f0492-006

Hexa Bike One 200 **A**



18,3 kg
Stainless steel 316 L
110 - 150 cm
127 x 60,4 x 101 cm
4
2 front
Without
z247f0492-001

Hexa Bike One 300 **A**



20 kg
Stainless steel 316 L
110 - 150 cm
120 x 60,4 x 101 cm
4
2 front
Without
z247f0492-013



Technical data

**SPORT
RESORT**

Weight
Material
Depth of use
Dimensions
Suction cup
Wheels
Brake
References

Hexa Bike Resort 100 **A**



18,3 kg
Stainless steel 316 L
110 - 150 cm
127 x 60,4 x 115 cm
4
2 front
Without
z247f0492-010

Hexa Bike Resort 200 **A**



25,1 kg
Stainless steel 316 L
110 - 150 cm
127 x 60,4 x 101 cm
4
2 front
Without
z247f0492-007

Water descent ramp **F**



Double inclined plane lets rolling the aquabike and descent it to the water at the place of the ladder into the pool of 1 meter deep.
Made of electro polished stainless steel.
Dimensions : 2,10m x 0,88m.
Tailor-made:
according to your pool configuration (contact us).

Non-contractual photos.



Technical data

Hexa Elliptique A

Hexa run Premium A

Hexa jump Premium A

**SPORT
PREMIUM**



Weight
Material
Depth of Use
Dimensions
Suction cup
Wheels
Brake
References

25,9 kg
Stainless steel 316 L
110 - 150 cm
135 x 60,6 x 145 cm
4
2 front
Without
z247f0492-002

35 kg
Stainless steel 316 L
120 - 140 cm
127 x 65 x 139 cm
6
2 front
Without
z247f0492-005

5 kg
Stainless steel 316 L
100 - 140 cm
ø 91 cm - H.21 cm
5
Without
Without
z645haqji01n000

Non-contractual photos.



85% muscle in action



SCAN TO WATCH
THE VIDEO

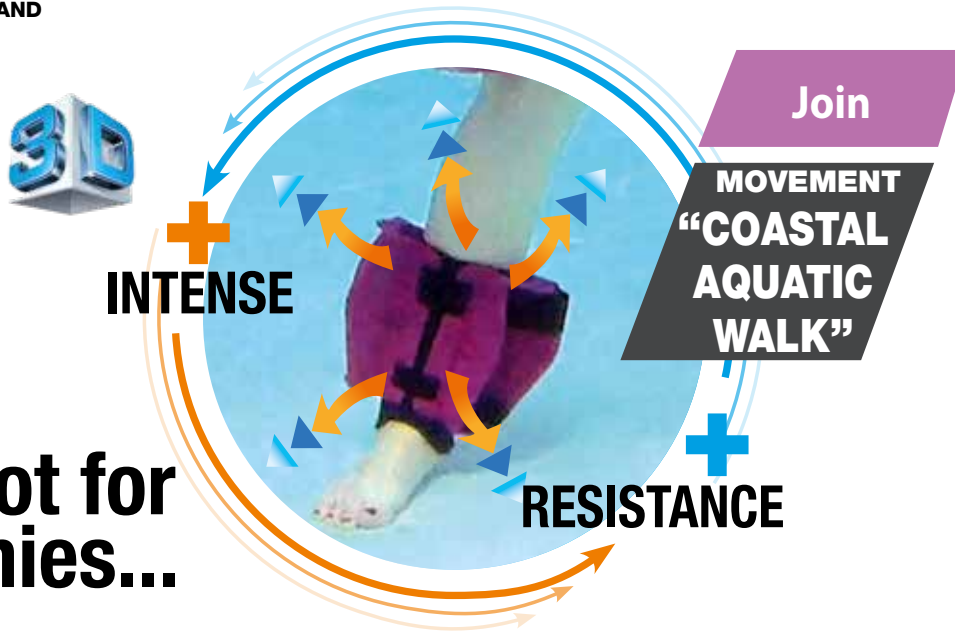

**...It's not for
grannies...**

Sustained physical exercise

Ideal for cardio, intense workouts

Can be practiced in all types of pools

Put in motion almost all muscles

A new way of **"WATER WALKING"**

Technical data

X-Trem bracelets **B**

X-Trem fins **B**

Complete X-Trem Kit **B**



Weight
Material
Depth of use
Dimensions
Colours
References

440 gr
ABS marine quality
No limited
ø 23 - P.16 cm
Pink or blue
z228hb00001n300
z228hb00001n500

380gr
ABS marine quality
No limited
L.20xP.12xH.21 cm
Pink or blue
z228hb00002n300
z228hb00002n500

440 gr/ 380gr
ABS marine quality
No limited
ø 23 - P.16 cm/ L.20xP.12xH.21 cm
Pink or blue
z228hb0001n300
z228hb0001n500
(2 bracelets and 2 fins)

Non-contractual photos.

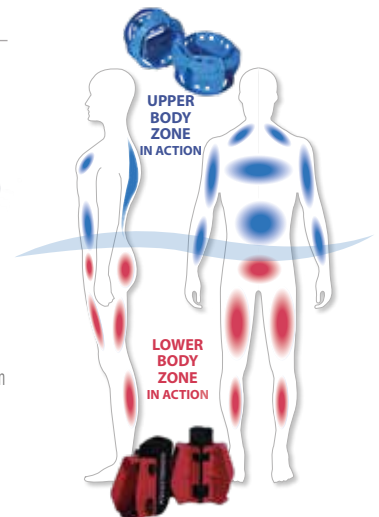

Hexagone, a multicolour high-

SONO

AQUABIKE / AQUA

Technical data

Hexa Sono **Premium D**

Hexa Sono **Optima D**

Hexa Sono **Pro X**

Hexa Bike **Optima 100 A**



Weight
Dimensions
Material
Depth of use
Suction cup
Wheels
Brake
Colours
Page number

17 kg
34,5 x 34,3 x 50,5 cm
—
—
No
2
—
1
70

7 kg
43 x 26 x 54 cm
—
—
No
4
—
1
70

35 kg
48 x 30 x 46 cm
Aluminum/ stainless steel
—
No
4
—
1
70

14 kg
115 x 92 x 66 cm
Polyethylene/ stainless steel
120 - 140 cm
8
2 front
Without
8 colours (please specify)
72

AQUABIKE / AQUA

Technical data

Hexa Bike **One 100 A**

Hexa Bike **One 200 A**

Hexa Bike **One 300 A**

Hexa Bike **Resort 100 A**



Weight
Dimensions
Material
Depth of use
Suction cup
Wheels
Brake
Colours
Page number

15,2 kg
84 x 60,4 x 120 cm
Stainless steel 316L
110 - 150 cm
4
2 front
Without
1
76

18,3 kg
127 x 60,4 x 101 cm
Stainless steel 316L
110 - 150 cm
4
2 front
Without
1
76

20 kg
120 x 60,4 x 101 cm
Stainless steel 316L
110 - 150 cm
4
2 front
Without
1
76

18,3 kg
127 x 60,4 x 115 cm
Stainless steel 316L
110 - 150 cm
4
2 front
Without
1
76

Non-contractual photos.

performance aquafitness range

AQUABIKE / AQUA COURSES DESIGN

Hexa Bike Optima 200 **A**



16 kg
120 x 160 x 66 cm
Polyethylene/ stainless steel
120 - 170 cm
9
2 front
With
7 colours (please specify)
73

Hexa jump Design **A**



9 kg
ø 106 cm x H.22 cm
Polyethylene/ stainless steel
80 - 170 cm
8
Without
—
7 colours (please specify)
75

Hexa run **A**



25 kg
135 x 82 x 153 cm (unfolded)
Polyethylene/ stainless steel
120 - 140 cm
8
4 front
With
7 colours (please specify)
74

Hexa multi exercise **A**



20 kg
ø 98 cm x H.170 cm
Polyethylene/ stainless steel
160 - 180 cm
10
Without
—
7 colours (please specify)
75

Hexa step **A**



16 kg
67 x 17 x 35 cm
Polyethylene
80 - 170 cm
8
Without
—
Lilac
75

Floating mattress Hexa paddle **F**



10 kg
220 x 81 x 12 cm
PVC reinforced nylon
No limited
—
—
—
1
75

COURSES SPORT

Hexa Bike Resort 200 **A**



25,1 kg
127 x 60,4 x 101 cm
Stainless steel 316L
110 - 150 cm
4
2 front
Without
1
76

Hexa Elliptique **A**



25,9 kg
135 x 60,6 x 145 cm
Stainless steel 316L
110 - 150 cm
4
2 front
Without
1
78

Hexa run Premium **A**



5 kg
ø 91 cm x H.21 cm
Stainless steel 316L
100 - 140 cm
5
Without
Without
1
78

Hexa jump Premium **A**



35 kg
127 x 65 x 139 cm
Stainless steel 316L
120 - 140 cm
6
2
Without
1
79

POOL AQUATIC WALK

X-Trem bracelets **B**



440 gr
ø 23 cm x P.16 cm
ABS marine quality
No limited
—
—
—
Pink or blue
79

X-Trem fins **B**



380 gr
20 x 12 x 21 cm
ABS marine quality
No limited
—
—
—
Pink or blue
79

Non-contractual photos.

1

PAGE 84

Sound ALARM DEVICE

with infrared sensor before going to the pool.



MANDATORY SHOWERING WITH SOAP

2

PAGE 84

DISTRIBUTOR of gel / shampoo

with capsules available near the showers.



3

PAGE 85

HIGH CHAIR

allows to safely leave a baby without the risk of falling while he and his parents are taking a shower.



Shower hygiene

A good practice initiati

Non-contractual photos.

Return to the locker room

on of showering and drying

5

PAGE 85

HAIR DRYER

before going out
to avoid colds.

4

PAGE 84

PEDICHLORE

for boot bath, a last
bastion to disinfect the
feet before the pool.



Boot bath passage

6

PAGE 86

FOR MORE COMFORT

SWIMSUIT WRINGER

in less than 10 seconds
without puddles in the
changing room.



Non-contractual photos.



Automatic sound signal for a mandatory soap shower

MADE IN FRANCE



Shower hygiene

Shower alert device **A**

Gel vending machine **E**

Shampoo vending machine **E**

Pedichlore **A**



Width 20 cm. Height 30 cm.
220V / 24V DC. Speaker 70 db.
IP66. Infrared sensor.
Detector up to 5m.
eks004n000



Styling gel - vending machine.
The machine holds up to 250 capsules

E Machine z169hvdgelstkn000fr
E Gel capsule z169hcapshrgl



Gel or shampoo capsule



Shampoo - vending machine.
The machine holds up to 250 capsules

E Machine z169hvdshpstkn000fr
E Shampoo capsule z169hcapsshmp



Boot bath superchlorination

Chlorine dosing device for a boot bath.

A In tablet of 250 gr z238f7000014

Non-contractual photos.

Chairs /Tables

Baby Hexa chair **F**



STACKABLE!

Dimensions (WxDxH) :60 x 50 x 76 cm.

Weight : 3,9 kg.

Black/grey z195fm212bg

Black/red z195fm212br



Changing table **F**



Dimensions (WxDxH) :40 x 50 x 120 cm.

z569f5569

Wall changing table **F**



Horizontal or vertical fixation.

F Horizontal z153f112523

F Vertical z153f113778



Hairdryer



Height adjustable Neptune **F**



180° rotation

Power: 2000W.

Sound level: 70 dB.

Colours: Red, blue, white.

Dimensions WxD.xH.): 15 x 34,8 x 38,4 cm.

(3 colours, contact us)

Height adjustable or fixed **F**



With mirror

Adjustable height 53 cm

Power: 2000W.

Sound level: 70 dB.

Colours : Yellow, green, red, grey, turquoise blue, blue.

Dimensions (WxD.xH.): 25 x 38 x 121 cm.

Height adjustable - Fixed

Wall mounted with flexible hose **F**



Robust ABS cover

Power: 900W.

Sound level: 72 dB.

Colours: White.

Dimensions (WxD.xH.): 32,2 x 18,2 x 80 cm.

z661ftb-c1

Wall mounted anti-vandal **F**



Long service life of induction motor

Power: 2100W.

Sound level: 70 dB.

Colours: White.

Dimensions (WxD.xH.): 25,5 x 28 x 14 cm.

z661f171227

Non-contractual photos.



An extra service for **your customers**



SCAN TO WATCH
THE VIDEO

DRY 'N' GO® !



MADE IN FRANCE



1• Put the swimsuit in the wringer



2• Close the lid before wringing



30dB
MAXI

95%
of the water

SQUEEZED OUT
IN LESS THAN
10 Sec.



Integrated
battery



3• Evacuation
of water by an
outer tube

Non-contractual photos.

Wrings out a swimsuit, eliminates 95% of water in 10 sec

Simple safe use

To easily put a swimsuit in a bag

Suitable for any environment

In stainless steel for perfect hygiene



DRY 'N' GO® !



Technical data

Dry 'n' Go XD Wringer **B**

Dry 'n' Go Wringer **F**



Power supply
Weight
Structure
Dimensions (WxDxH)
References

Motorized with battery
25 kg
Stainless steel
54 x 35,5 x 82 cm
xdngn000

Motorized 220V
30 kg
Stainless steel
54 x 35,5 x 82 cm
z184hssd-silver

Non-contractual photos.



Your wellness area



HEXAGONE PRODUCTION



Range up to 150 meters

1

A special inside high temperature resistant sauna button



Special Sauna panic button

2

An outside waterproof wireless warning button

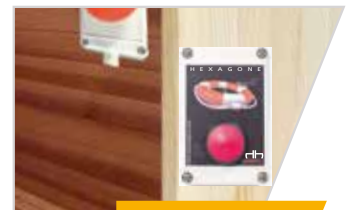

Double internal and external security alert

Warn of discomfort in an unsupervised area

Resistant to high temperature up to 110 °

Protected by international patent

Solution against small impurities in the Spa



Non-contractual photos.

Sauna / Spa/ Steam room security

Technical data

LED box with speaker **A**

Standard wall panic button **A**

Special Sauna panic button **A**



Power supply
Protection
Range
Waterproof
Autonomy
Dimensions
References



Prise 220 V
IP 65
150 m
Yes
—
254 x 180 x 90 mm
eks001n000

Displays the triggered button area



Battery 3,2 V
IP 65
150 m
Yes
18 month
100 x 65 x 40 mm
egs002n001

Ideal for unsupervised zones



Battery 3,2 V
IP 65
150 m
Yes
18 month
100 x 65 x 40 mm
Inside button egs004n000

Resistant up to 110°!

THE SAUNA KIT

A eks014n000

Spa cleaning

Technical data

Quick Vac' spa **B**

Quick Vac' spa turbo XL **B**

Lineo Spa **B**



Width
Suction power
Power
Filtration (microns)
Filtration capacity
Autonomy
Minimum water depth
Power supply
References



ø 11 cm
9m³/h
120 W
50 or 100 µ
500 gr
1h
15 cm
Battery/ Power supply
z160hplwrv2/ **B** - z160hplwrv2sct **B**

NEW!



40 cm
15m³/h
250 W
50 or 100 µ
About 1 kg of sand
2h
21 cm
12V rechargeable battery
z160hplwrxl



ø 10 cm
—
40 W
—
—
1h
—
12V
xlineospa

Disabled access for Spa

Technical data

Autonomous mobile Unikart **F**

Autonomous fixed Unikart **F**

Motorized Unifix XD **F**



Use
Max lifting load
Weight
Power supply
Dimensions (WxDxH)
Trolley/ Seat
System
Seat course
References

Great height



Autonomous
Up to 136 kg
542 kg
24V battery
249 x 72 x 168 cm
Aluminium/ stainless steel/ rotomolded
Motorized
138 cm
Z797f275-0000eu



Autonomous
Up to 136 kg
127 kg
24V battery
171 x 50 x 234 cm
Aluminium/ Galvanized steel
Motorized
170,5 cm
z797f310-0000ceu

AUTONOMOUS!

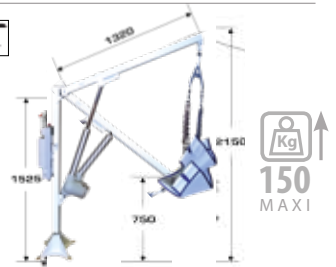

Intensive
Up to 150 kg
60 kg
2 batteries
132 x 30 x 152,5 cm
Galvanized steel/ hammock or seat
Motorized
140 cm
Attachment plate z190fpv01-3 - Coring z190fpv01-2
Gallows alone

Non-contractual photos.



Storage studied for your **swimming pool**

Shelves

Rack with 4 shelves **F**



Dim. (WxDxH) : 150x50x190 cm
z165fms1500/500

Rack with 3 shelves **F**



Dim. (WxDxH) : 120x50x150 cm
z354F9344

Shelving unit for mats storage **F**



Dim. (WxDxH) : 140x60x225 cm
z165fms(pr)

Shelving unit for noodles **F**



Dim. (WxDxH) : 135x57x150 cm
z165fnd1350

Shelving unit with closing box **F**



Dim. (WxDxH) : 135x57x150 cm
z165fnd1350dr

Benches

Simple bench **F**



Dim. (DxH) : 35x49 cm
W.90cm z165fb900/350
W.150cm z165fb1500/350

Long simple bench **F**



Dim. (DxH) : 45x49 cm
W.200cm z165fb2000/450
W.300cm z165fb3000/450

Double side bench **F**



Dim. (DxH) : 75x49 cm
W.150cm z165fb1500/750
W.200cm z165fb2000/750

Simple bench with hanger **F**



Dim. (DxH) : 45x170 cm
W.100cm z165fbh1000/450
W.150cm z165fbh1500/450

Double bench with hanger **F**



Dim. (WxDxH) : 150x71x170 cm
z165fbh1500/710

Non-contractual photos.



OPTIMA PLASTIC

5 colours available over all storage range



Yellow



Blue



Red



Cream



Green



Boxes

Aquagym rack **F**



Dim. (WxDxH) : 72x65x105 cm
z165fndl(mini)

Box for small objects **F**



Dim. (WxDxH) : 120x70x90 cm
z165fts(s) (with cover)
z165fts(s) (without cover)

Aquagym storage unit **F**



Dim. (WxDxH) : 144x69x111 cm
z165ft(s)ndl (with cover)
z165ft(s)ndl (without cover)

Shelving aquagym **F**



Dim. (WxD) : 176x76 cm
H.192 cm z165fmega12notoprack
H.227 cm z165fmega12toprack

Aquagym box cabinet **F**



Dim. (WxDxH) : 126x76x156 cm
Z165ft(l) (with cover)
Z165ft(l) (without cover)

Boxes

Robust box **F**



Dim. (WxDxH) : 100x80x70 cm
z255fpe-rts2

**PREMIUM
ALU**

Multi-objects box **F**



Dim. (WxDxH) : 100x65x95 cm
z255fpe-rts1

Bins & barriers

Frog Arnold bin **F**



Diameter 0,70 cm.
Height 0,80 cm. Resin.
z371ffegr-002

Non-contractual photos.

Dolphin Willy bin **F**



Diameter 0,70 cm.
Height 0,80 cm. Resin.
z371ffegr-001

Plastic barriers **A**

Shatterproof



White Yellow Red Green Blue
Weight 9,2 kg. Recyclable 100%.
198x55,5x102 cm (weight foot).
(5 colours contact us)



Tested and certified
at 1500 kg

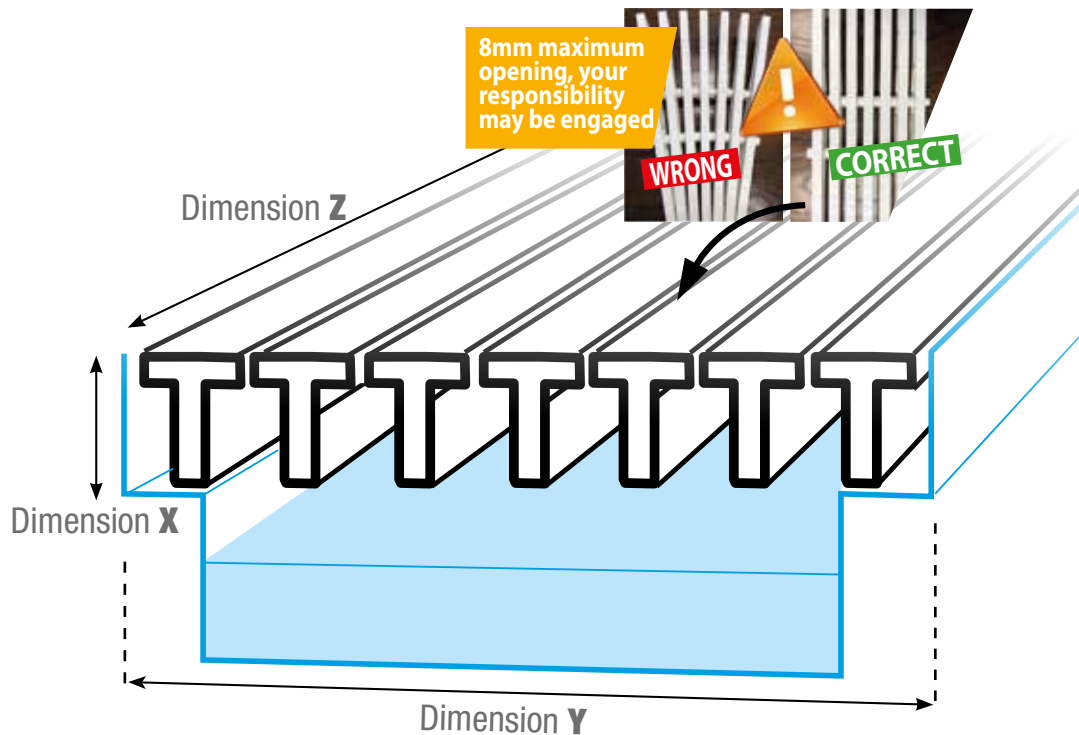
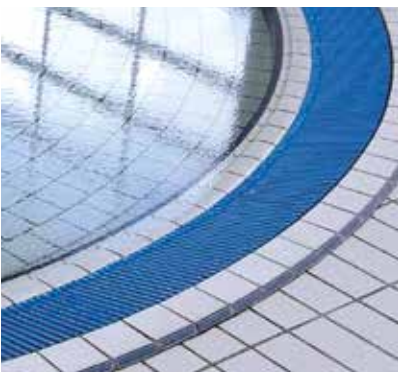
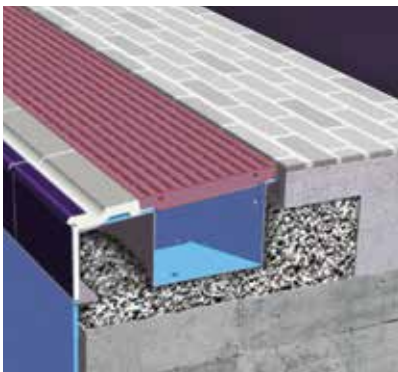

In 16 colours*

*Contact us

Non-contractual photos.



Different height, width, length and colours

Adapts to the shapes and features of your pool

Ultra-resistant 1500 Kg/m²

Specific design with anti-slip grooves

5 years warranty

Perpendicular gutter grates 



Height (x)	Rigid (y)	Curvable (y)
22 mm	175 to 295 mm	150 to 295 mm
25 mm	175 to 400 mm	150 to 330 mm
30 mm	175 to 500 mm	150 to 330 mm
35 mm	175 to 900 mm	150 to 330 mm
Length (z)	in standard sections of 2.5 m	in standard sections of 1 m

Parallel gutter grates 



Height (x)	Width (y)	Length (z)
25 mm in I	150 to 400 mm	elements of 1 m
25 mm PVC	standard 245 mm	elements 250 mm
25 mm PP	standard 245 mm	elements 500 mm
25 mm	182, 254, 330 mm	elements 333 mm
35 mm in T	150 to 400 mm	elements of 1 m

Curvable gutter grates 



Height (x)	Width (y)	Length (z)
25 mm	180, 200, 205, 250, 300 mm	segments of 1 m
35 mm	195, 245, 295, 335 mm	segments of 1 m

Non-contractual photos.

HEXACONTROL

HEXAGONE PRODUCTION

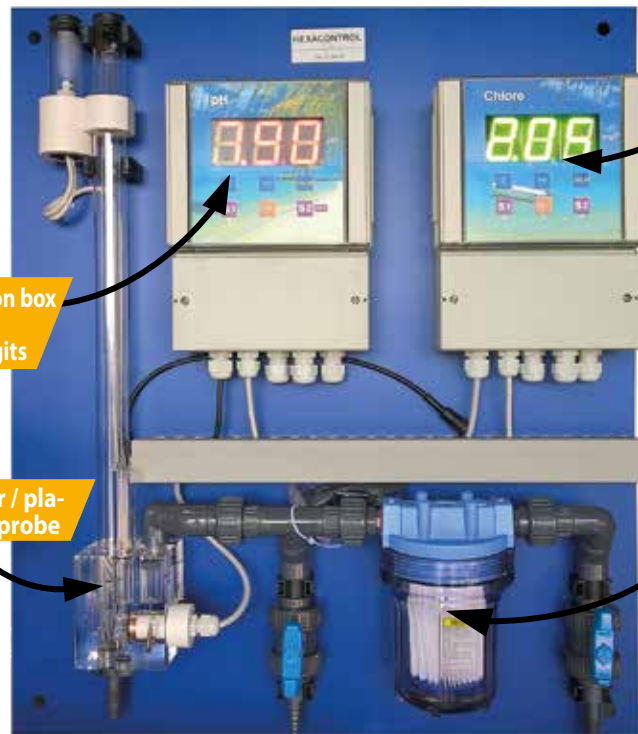

pH regulation box with very readable digits

Chlorine regulation box with very readable digits

Copper / platinum probe

Regulation filter holder + filter



More than 3000 users

Reliable measurements thanks to a special analysis chamber

Easy to take samples

Data transmission in 4-20mA

XXL display of chlorine and pH

Regulation

Amperometric regulation **A**



More than 3000 users!

Ideal for dark technical rooms. Well readable large display. Chlorine and pH box. Probe block with stabilized flow. Copper/ platinum chlorine and universal pH probes integrated. Flow detector. Integrated sample taking (Installation not included.)

- A** Complete Ch / pH regulation z243hxr0012n001
- A** Complete Ch regulation z243hxr0010n000
- A** Complete pH regulation z243hxr0002n000

Probes **A**



- A** Ch probe without wire z243f5636ccp
- A** Ch probe with wire z243f963sa
- A** Universal pH probe z348f00404531-20.1

Dosing tank **D**



- The polyethylene dosing tank allows you to safely store from 50 to 250 liters of liquid products. The solution will be injected by a dosing pump.
- D** 50 liters tank z218f57613
 - D** 100 liters tank z218f46562r
 - D** 250 liters tank z218f01315

Non-contractual photos.

Reliable and accurate analysis

Photometers

Photometer PC 03 **F**



Works with
DPD tablets
(contact us)

It provides numerical results for 3 key parameters: Chlorine, pH and Stabilizer (Cyanuric Acid). Waterproof with a large LCD backlit display.
z276fsp003d

Photometer PC 09 **F**



Works with
DPD tablets
(contact us)

It allows the analysis of 9 tests (Chlorine, pH, CYA, TA, TAC, TH, OZ, CU, BR, FE). Downloadable and shareable data via Bluetooth or USB SMART.
z276fsp709e

Municipal testing kit **F**



Colorimeter, comparator, disks, 6 functions. Square test tubes, accessories. Chlorine, pH, TAC, TH Calcium and Stabilizer (Cyanuric Acid) analysis.
z276fsp129c

Sanitation diary **F**



The sanitation diary for public or residential swimming pools. Each page allows you to record your observations and analysis for all 7 days of the week.
z294f8400004

Round test tube **A**



10 ml. In glass. Set of 5.
A Large z276fpt595
A Wide z276fpt555

Square test tube **A**



10 ml. In glass. Set of 5.
z276fpt521/5

Tablets

DPD 1

250 box.

A Black for photometer
z276fap011

DPD 3

250 box.

A Black for photometer
z276fap031/1

DPD 4

250 box.

A Black for photometer
z276fap041

DPD stabiliser

250 box.

C 100 box.
z276fap087

DPD Phenol red

250 box.

A Black for photometer
z276fap130

A Green manual
z276fat010

A Green manual
z276fat030

A Green manual
z276fat040

C 250 box.
z276fap087/250

A Green manual
z276fat130

Thermometers

Black & Decker thermometer **A**



Electronic infrared thermometer.
z094ftld100-xj

Buoyant thermometer **F**



Floating thermometer.
z303f2381

Classic thermometer **F**



Anchor thermometer.
z303f5021

Electronic thermometer **F**



Electronic thermometer with probe.
z368fhi98509n

Pumps

Dosing pump from 0.1 to 200L / H **F**

Other models, contact us



Designed for injecting liquid products such as pH-regulating agent. It can be programmed to regulate chlorine and pH.

F 5 liters/h z237fakl603nhh0000

F 10 liters/h z237fakl800nhh0000

F 20 liters/h z237fakl803nhh0000

Normblock Multi Pump **■**



Innovative circulation and filtration pump for public pools and aqua parks. Horizontal entirely plastic block.

Consult us

Badu Block Multi Pump **■**



Circulation and filtration pump for public pools and aqua parks. Non-self-priming, single-stage, volute casing in vertical monobloc design. The low speed of the motor guarantees reduced wear.

Consult us

Non-contractual photos.

Ressort Pump **■**



Circulation pump for swimming pools of hotels and campsites, or special pools. Monobloc with integrated tank. The motor shaft has no contact with water to ensure complete electrical separation. Consult us

3 kg of salt = 1 kg of

100% chlorine

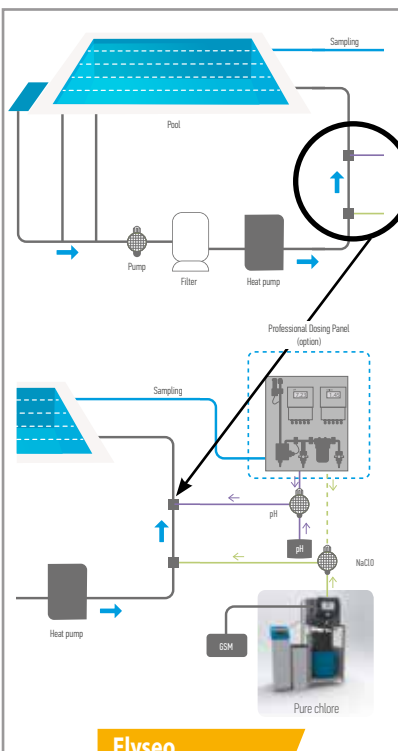

Elyseo installation diagram



Control panel, remote alert via GSM



Softener with large volume of resin

Large capacity salt storage tank

Optimal chlorine preservation

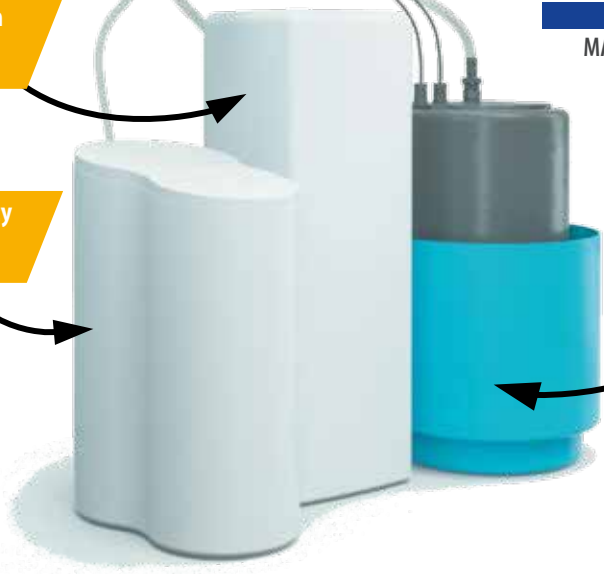

Reduced operating cost

No more chlorine manipulation

No more deterioration of chlorine quality

Respect the environment

For a pool from 200 m³

Non-contractual photos.

Technical data



For pools up to
Electrodes of production
Chlorine production capacity
Salt consumption (1 kg produced chlorine)
References
Installation not included

Elyseo 2 electrodes **D**

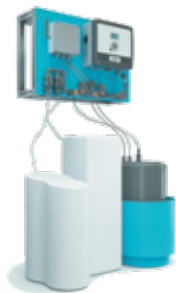

200 m³
2
3,4 kg/day
3 kg
z565fpure17p00140

Elyseo 4 electrodes **D**



500 m³
4
6,7 kg/day
3 kg
z565fpure17p00280

Elyseo 8 electrodes **D**



1000 m³
8
13,4 kg/day
3 kg
z565fpure17p00560



Storage and protection

Bottle tray **F**

Other models, contact us



Dimensions : 63,5 x 41,5 x 20,5 cm.
Volume 40 liters.
z182f042.574.44

Tray for cans and drums **F**



Dimensions : 120 x 64 x 15 cm.
Volume 100 liters.
z182f000.695.85

Motorized transfer pump **F**



Suitable for cans of 20 to 200 liters.
z206f31441010 alone
z206f31443010 complete

Manual transfer pump **■**

Other models, contact us



Suitable for cans of 40 to 110 liters.
Contact us

Mask and cartridge



Gas mask alone. z278f1710394 **F**
Type B cartridge. z278f1785030 **A**

PVC apron **A**



PVC. One size.
z246f9510500001

Chemical resistant gloves **F**



PVC. One size.
z080f050230384
Non-contractual photos.

Tigergrip overshoes **F**



Safety overshoes.
Yellow z183httprt-34-36-s
Brown z183httprt-37-40-m
Red z183httprt-41-44-l
Green z183httprt-45+-xl

Save water and energy

Deca 20

WITH PREMIUM COVER LOSS OF 0.65 °C

WITHOUT PREMIUM COVER LOSS OF 5 °C

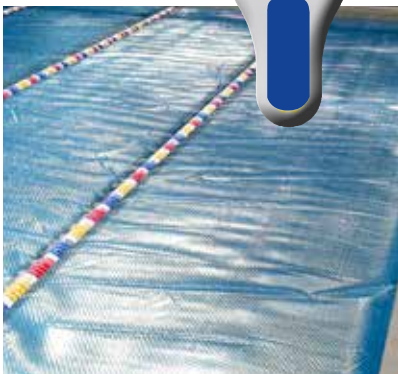

Handle for winding or rolling the cover



Radio remote control for motorized version

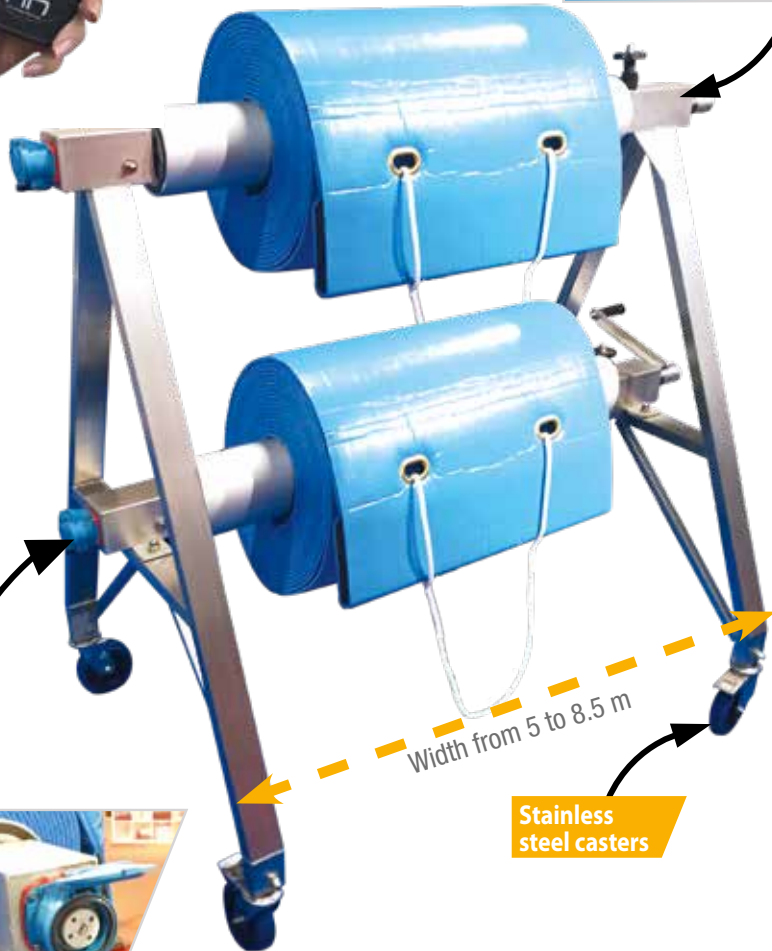

Width from 5 to 8.5 m

Stainless steel casters

Connection point for motorized version



Non-contractual photos.

Reels

Simple mobile reel system **F**



Manual or motorized

For swimming pool up to 8 x 50 m

Anodized aluminum tube with a diameter of 130 mm

On casters

Max. strip size	Manual	Motorized 120Nm*
5 x 25 m	z074fv-enca01300	z074fv-enca01400
6,25 x 25 m	z074fv-enca01301	z074fv-enca01402
8 x 25 m (manual)	z074fv-enca01302	z074fv-enca01404

*In 250 Nm, contact us

Double mobile reel system **F**



Manual or motorized

For swimming pool up to 16 x 25 m

Two anodized aluminum tubes with a diameter of 130 mm

On casters

Max. strip size	Manual	Motorized 24V
5 x 25 m	z074fv-enca02300	z074fv-enca02400
6,25 x 25 m	z074fv-enca02301	z074fv-enca02401
8 x 25 m (manual)	z074fv-enca02302	z074fv-enca02402



Covers



Bubble eco cover **A**

400 gr/M²

For swimming pools up to 20m.

Supple bubbles.

Translucent.

z238fspecial



Foam cover Optima **A**

5 mm

For swimming pools up to 50m.

Closed cell foam.

Blue color.

z074fisodeleco5



Foam cover Premium **A**

7 mm

For swimming pools up to 50m.

Closed cell foam.

Blue color.

z074fisodellux7



Winter debris

Winter cover **A**

550 gr/M²

For swimming pools up to 14m.

In polyethylene.

Green color.

Contact us

Non-contractual photos.

Heat, ventilate, dehumidify

your shelter



3 versions:
fuel, natural gas
or propane

Available in
several colours
on request

Easy installation
outside your
shelter



Go from 0 ° to 25 ° **in less than 15 minutes** with your heater.

In summer, your shelter is not an oven, the heater provides ventilation with a temperate air.

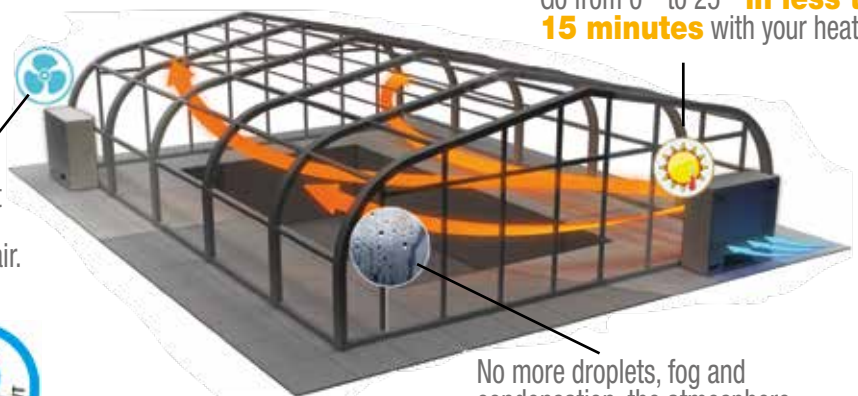

No more droplets, fog and condensation: the atmosphere is always pleasant and healthy.



Non-contractual photos.

Heats in winter, ventilates in summer

Dehumidifies and fights droplets

Swimming possible all year round, assured comfort

Regulated temperature with minimum energy cost

Fast delivery and commissioning



**HEXA
SUN**

**Very
economical !**

**UNIQUE
ENERGY
EFFICIENCY**



Technical data

Energy
Body
Winter consumption
Mid-season consumption
Dimensions W. x D. x H.)
References
installation not included

Hexa Sun F

Fuel, natural gas or propane
Stainless steel with epoxy paint
2,8L/h of fuel (20h of autonomy)
1,5L/h of fuel (40h of autonomy)
135 x 55 x 137 cm
Fuel - natural gas - Propane
Contact us

Non-contractual photos.



Always close
to you

More than 55 countries in the world



ARMAND DE LA LOYÈRE
Export Director
Gsm : +33 (0)6 23 36 67 11
E-mail : adl.hexagone@gmail.com

Non-contractual photos.

7 subsidiaries in Europe

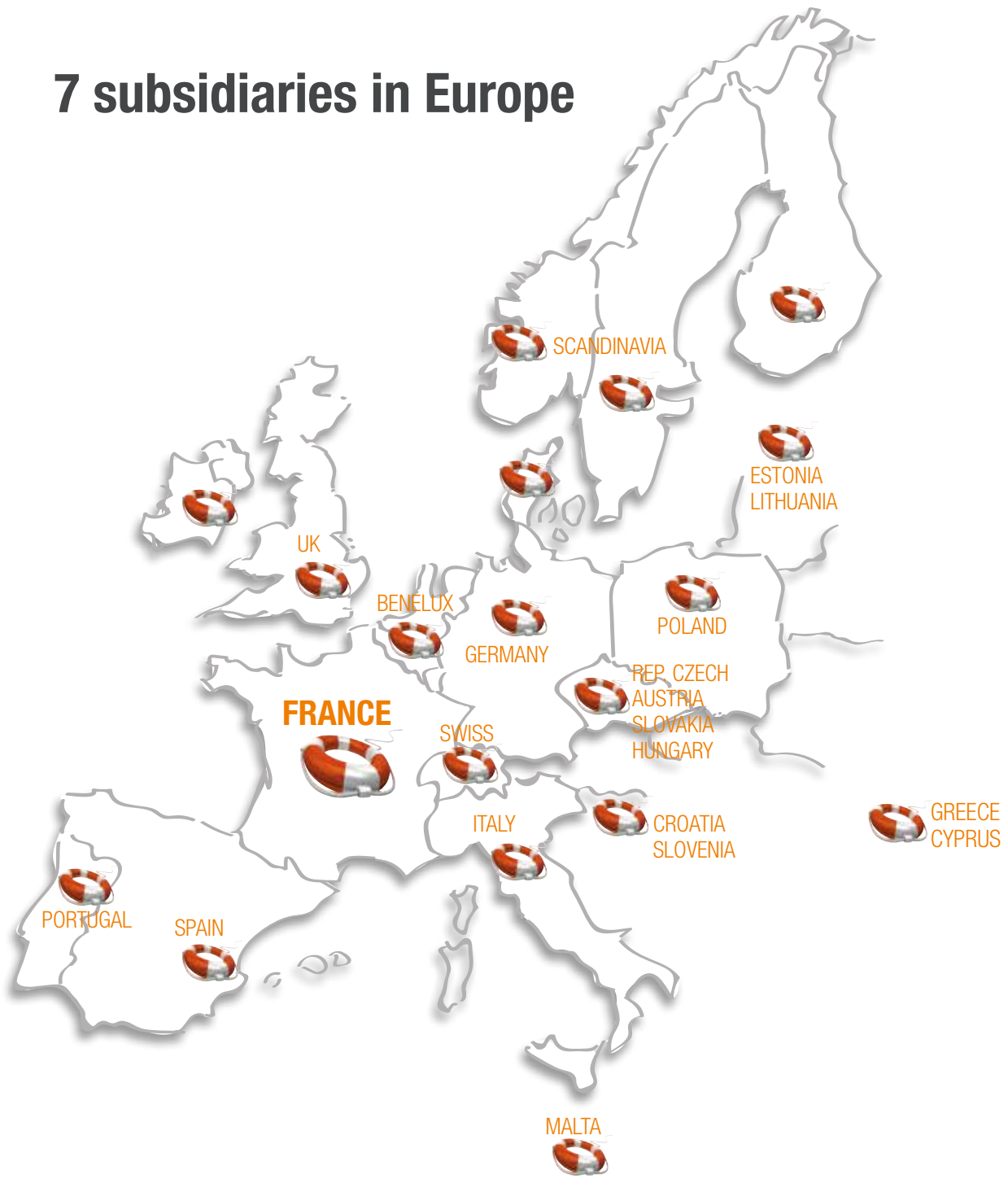

OLIVER GUMBRECHT
Germany
Manager



FABRIZIO FERRARI
Italy
Manager



MICHEL VAN DEURZEN
Benelux
Manager



JEAN DILIBERTO
Frankrijk
Manager



BRAD ATTWOOD
UK
Manager



NORBERT MORI
Switzerland
Manager



JOSUE GARCIA
Spain
Manager

Non-contractual photos.



GROUP OF
10 M€

Localisation

- Argenteuil, 6500m²
- 9 after sales service points in France
- 7 subsidiaries with office and storage (Germany, Italy, Spain, the UK, Benelux, Denmark, Switzerland)
- 55 distributors worldwide

1,2 M€
IN INVESTMENTS

R&D

- 6 dedicated engineers: mechanics, electronics, mechatronics, vehicle architecture
- Computer-assisted creation with Solid Edge and SpaceClaim
- 18 product developments in 24 months
- 3D printing for prototyping

Hexagone organiz



HEXAGONE
MANUFACTURE

MADE IN
FRANCE

Production

- 5S method throughout the plant, 600 tests per day
- Stainless steel workshop, selection of raw materials, section of tubes, weld control and quality of electropolishing
- Motors and pumps workshop with electrical, hydraulic and sealing tests
- Electronic workshop with severe durability tests

2 M€
OF STOCK

Logistics

- Import of more than 1.6 million in 2018
- Contracts with Fedex, DPD, Geodis, Dachser for transportation to ship within 24 hours
- Shipping by sea containers and air freight
- CACES license of our logisticians
- 5000m² of storage

Non-contractual photos.



group ation

SERVICE ON
SITE

70%
OF PUBLIC
POOLS

Commercial

- World References (Rio 2016 and London 2012 Games, World Championship in Budapest 2017, Hangzhou 2018 and Gwangju 2019)
- Number 1 in France, 35% of public swimming pools in Europe and 15% in the world
- Dedicated export service
- Integrated communication support (catalog, website, data sheets, mobile app)

After sales service

- Hot line technical assistance from 7:30 to 18:00, 5 d / 7
- Factory workshop with test pool
- 11 traveling technicians
- Storage of robots in winter
- Training workshops for technicians and distributors, level 1 to 3



ANNUAL
OR SUMMER
SEASON
RENTAL

Funding

- Lease (self-financing) contract of our products
- Electronic invoicing
- Ranking of Hexagone at the top in the banks and Institut Plimsoll
- Management under SAP software
- Revenue increased by 40% in 3 years



Engagement

- Support for apprentices within the company
- Professional tax dedicated to a school for the disabled
- Donor of an association **theshoethatgrows.org**
- Recycling of our equipment
- Regular replacement of our vehicles to lower the carbon footprint
- Commitment to the UNO Code of Professional Ethics

Non-contractual photos.

ACCOUNT OPENING

PHOTOCOPIY

Please complete this form and return it with the following documents: a Kbis extract of less than 3 months, a Bank Statement, letterhead with SIRET number, our GSC signed with name, first name and function of the signatory and stamp of the company with SIRET number, bear the words «read and approved»

GENERAL INFORMATION

Company name* :

LEI (Legal Entity Identifier)* VAT number*

Address* :

Post code* : City* : Country* :

Tel* : Fax* : General email* :

Email for order acknowledgments* :

Delivery address (if different) :

Post code : City : Country :

Tel for delivery* : Fax :

Specify your closing days* : Reception hours* :

Delivery constraints :

**essential information to open the account*

MANAGEMENT CONTACT*

Mrs./Ms. Mr.

Surname : First name :

Position : E-mail :

Fax : Cell phone number* : Tel :

PROCUREMENT DEPARTMENT CONTACT*

Mrs./Ms. Mr.

Surname : First name :

Position : E-mail :

Fax : Cell phone number* : Tel :

ACCOUNTING DEPARTMENT CONTACT*

Mrs./Ms. Mr.

Surname : First name :

Position : E-mail :

Fax : Cell phone number* : Tel :

Do you have a payment procedure? Yes (send us your purchase conditions). no

Payment terms and conditions:

First order: full payment ahead of the order. Next order: according to validation of our Financial Service.

Any order placed in Hexagone Manufacture implies that the customer fully and unconditionally accepts the general conditions of sale, excluding any other document. The customer acknowledges in particular that the goods remain the property of Hexagone Manufacture until full payment of their price. The company Hexagone Manufacture reserves the right to suspend or cancel any account whose holder has not respected the terms and conditions of sale of Hexagone Manufacture or the defined method of payment.

Name, surname, position and signature. Mark «read and approved»	Date :	Company stamp
--	--------	---------------



HEXAGONE

MANUFACTURE

2019-2020

100% PRO



Your everyday **partner**

www.myhexagone.com



Our Youtube channel:
hexagone manufacture



Facebook :
myhexagone



Twitter :
@HexagoneManufac



Our application:
App Store and Android
(opening May 15, 2019)



Our flash code:
watching products videos



PEFC
PEFC/14-38-00020
Our catalog comes from sustainably managed forests and controlled sources.

MADE IN FRANCE

1-5 Rue Michel Carré 95100 Argenteuil - France •
Tél : +33 (0)1 34 34 11 55 • Fax : +33 (0)1 34 34 11 50 • E-mail : info@myhexagone.com

